

# Installation manual

Montageanleitung • Notice de montage • Istruzioni per il montaggio • Manual de montaje • Monteringsanvisning •  
Installatiegids • Montážní návod • Asennusohje • Installationsmanual • Instrukcja instalacji • Paigaldusjuhend

## Log cabin FR44-4132-2

Blockhaus • Maissonnette en poutres • Casa di travi • Casa de jardin • Anneks • Tuinhuis • Zahradní domek •  
Timmerstuga • Hirsimökki • Dom z bali • Freesprussmaja

Width 410 x Depth 320 cm











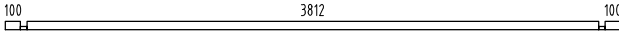
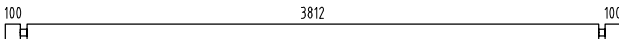
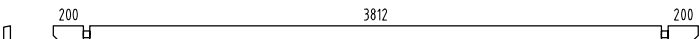
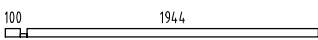

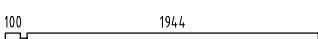



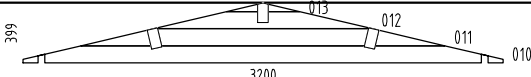
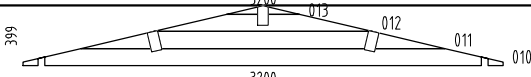

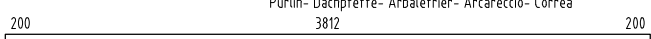
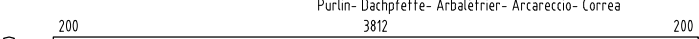

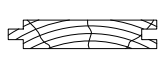
Breite/Tiefe • Largeur/Profondeur • Lunghezza/Profondità • Ancho/Profundidad • Bredde/Dybde • Breedte/Diepte  
• Šířka/Hĺoubka • Leveys/Pituus • Bredd/Längd • Szerokość/Głębokość • Laius/pikkus

Log thickness 44 mm











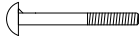
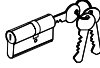







Bohlenstärke • Épaisseur des murs • Spessore delle pareti • Grosor de pared • Tykkelse • Wanddicke • Tloušťka  
stěny • Seinän paksuus • Väggtjocklek • Grubość ścian • Seinapaksus

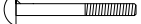
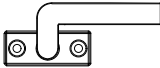

The producer shall have the right to make technical changes to the product • Technische Änderungen vorbehalten • Le  
producteur réserve le droit d'effectuer des modifications techniques au produit • Il produttore mantiene il diritto di apportare  
modifiche tecniche al prodotto • Reservado el derecho a modificaciones técnicas • Produsent forbeholder seg retten til å endre  
tekniske egenskaper ved produktet • Alle rechten en technische wijzigingen voorbehouden • Výrobce si vyhrazuje právo na  
technické změny výrobku • Valmistaja pidättää oikeuden tehdä tuotteeseen teknisiä muutoksia • Tillverkaren har rätt att utföra  
tekniska förändringar för produkten • Producent zastrzega sobie prawo do dokonywania zmian technicznych produktu • Tootja  
jätab endale õiguse muuta toote tehnilisi omadusi

Pos	SPECIFICATION-STÜCKLISTE-NOMENCLATURE-ELEMENTI-ESPECIFICACIÓN FR44-4132-2	Pcs	Profile (mm)	Length (mm)
001		1	44x57	4100
002		18	44x114	4100
003		2	44x114	4300
004		1	44x57	2088
005		1	44x57	392
006		5	44x114	2088
007		27	44x114	392
008		22	44x114	143
009		36	44x114	3200
WA-1		1		
WB-1		1		
AR1	Foundation- Fundament - Fondazione- Vigas de cimentación 	6	70x45	3890
PR1	Purlin- Dachpfette- Arbalétrier- Arcareccio- Correa 	2	70x140	4300
PR2	Purlin- Dachpfette- Arbalétrier- Arcareccio- Correa 	1	70x140	4300
FB2-1	Floor board- Fussbodenbrett- Madrier du plancher - Tavola pavimento- Tabla de suelo 	43	89x19	2905
RB2-1	Roof board- Dachbrett- Madrier du toit- Tavola tetto- Tabla de tejado 	98	89x19	1760
Dia-1	Diamond- Deckbrett- Madrier- Tavola di copertura- Rombo 	2	19x140	300
EaE1-1	Eave edging- Dachrandbrett- Madrier en bordure du toit- Tavola bordo tetto- Tabla de valadizo 	2	16x95	4300
FaB3-1	Facia board- Giebelblende- Écran frontal- Schermo frontone- Tabla de facia 	4	16x120	1800
FIB2-1	Floor beading- Fussbodenleiste- Baguette du plancher- Listello pavimento- Listón de suelo 	7	19x19	2050
RE2-1	Roof edge reinforcement- Dachrandleiste- Baguette en bordure du toit- Rinforzo bordo tetto- Refuerzo borde tejado 	2	32x40	4300
QT18-1	Seal- Gummidichtung- Joint d'isolation- Guarnizione- Burlete 	2	A44-81	3700
QT18-2	Seal- Gummidichtung- Joint d'isolation- Guarnizione- Burlete 	1	TU44-81P	5500
SlA10-1	Slat- Leiste- Baguette- Listello- Listón 	1	19x45	1620
StB1-1	Storm brace- Sturmleiste- Protection contre le vent- Antivento- Protector contra tormentas 	4	25x45	2050

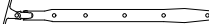
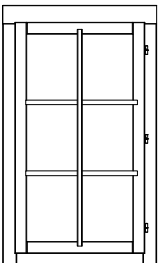

Pos	SPECIFICATION-STÜCKLISTE-NOMENCLATURE-ELEMENTI-ESPECIFICACIÓN FR44-4132-2		Pcs	
Fim	-Fixing kit- Befestigungsset- Moyens de fixation- Materiale di fissaggio- Kit de fijación		1	USE
QP0YP8x 80Zn	Bolt -Schloss-schraube -Boulon- Bullone- Perno- M8x80mm PUP0		8	StB1-1
QULSI30x 35	Cylinder- Zylinderschloss- Serrure a mortaiser- Serratura a cilindro- Bombin- 30.35		1	TU44-81P
QLIU KAPal	Door fittings- Türbeschlag- Ferrure- Ferramenta porta- Manilla puerta- QLIUKAPal		1	TU44-81P
QRV1 20Zn	Keeper- Schliessblech- Tole- Lamiera- Aldaba de candado- 120Zn		1	TU44-81P
QNA1 4x 40Me	Nail- Nagel- Clou- Chiodo- Clavo- 1.4x40mm		30	FIB2-1
QNA2 2 x50Zn	Nail- Nagel- Clou- Chiodo- Clavo- 2.5x50mm		600	FB2-1; RB2-1
QMUkK8 Zn	Nut- Schraubenmutter- Écrou- Dado- Tuerca- M8mm		8	
QKRPP2 5x16Z n	Screw- Schraube- Vis- Vite- Tornillo- 2.5x16mm		2	
QKRPP3 5x40Zn	Screw- Schraube- Vis- Vite- Tornillo- 3.5x40mm		80	Dia-1; EaE1-1; RE2-1; FaB3-1
QKRPP3x 20Zn	Screw- Schraube- Vis- Vite- Tornillo- 3x20mm		28	A44-81 TU44-81P
QKRPP4 5x70Zn	Screw- Schraube- Vis- Vite- Tornillo- 4.5x70mm		16	001; 003; 004; 005; PRx
QKRPP5x 90Zn	Screw- Schraube- Vis- Vite- Tornillo- 5x90mm		4	TU44-81P
QSE8x22 Zn	Washer- Dichtscheibe- Joint- Rondella- Arandela- 8x22mm		8	
QLIA-P	Window fittings- Fenstergriff- Poigne de la fenêtre- Maniglia finestra- Manilla- QALpainP		1	A44-81
QLIA-V	Window fittings- Fenstergriff- Poigne de la fenêtre- Maniglia finestra- Manilla- QALpainV		1	A44-81
QFK240Z n	Window stop- Fensterfeststelle- Crémaille- Fissativo finestra- Fijador de ventana- QFK240Zn		2	A44-81
A44-81V	Window - Fenster - Fenetre - Finestra-Ventana 700x1210     600x1110mm		1	
			Object name FR44-4132-2	Page 2/3



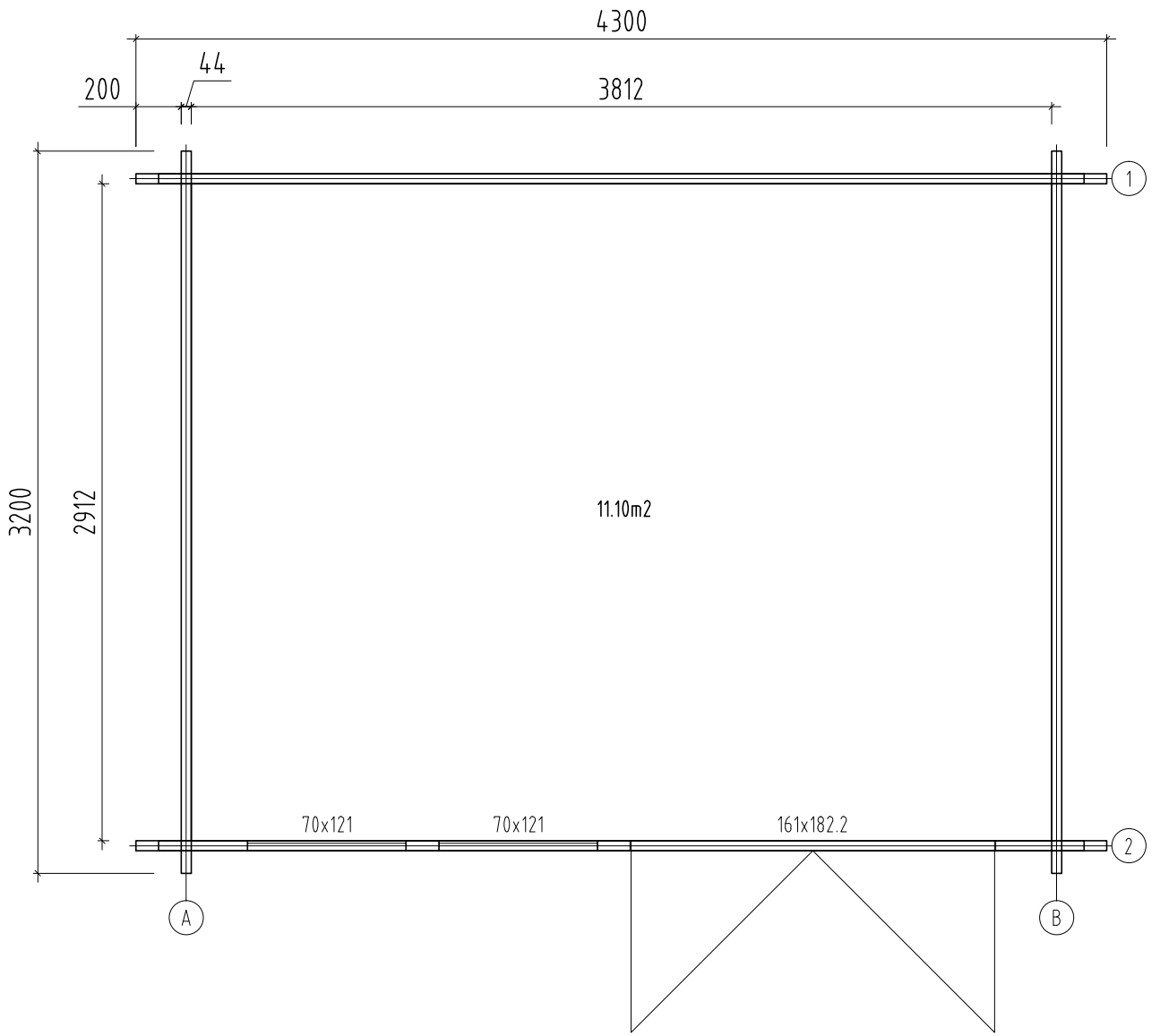

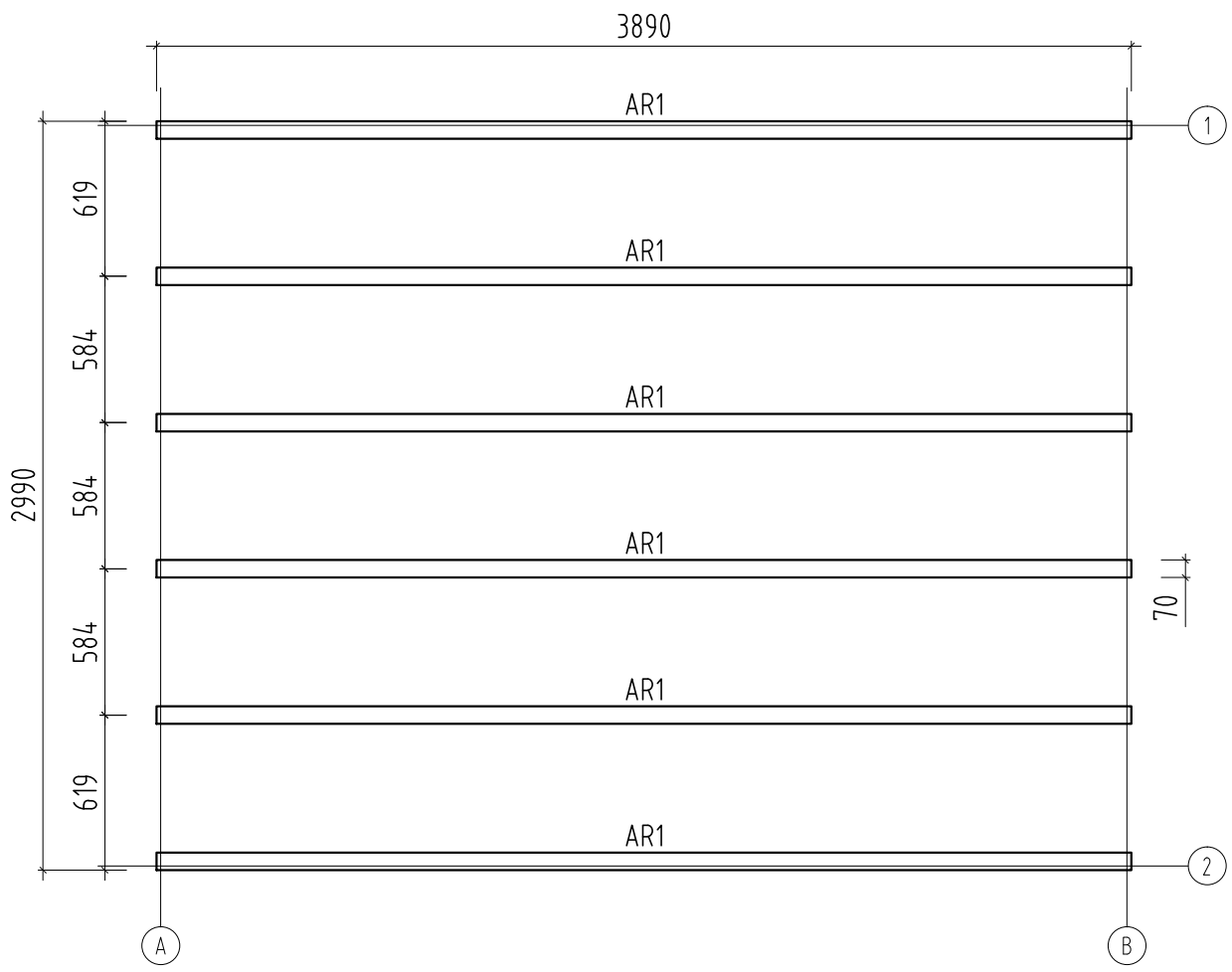



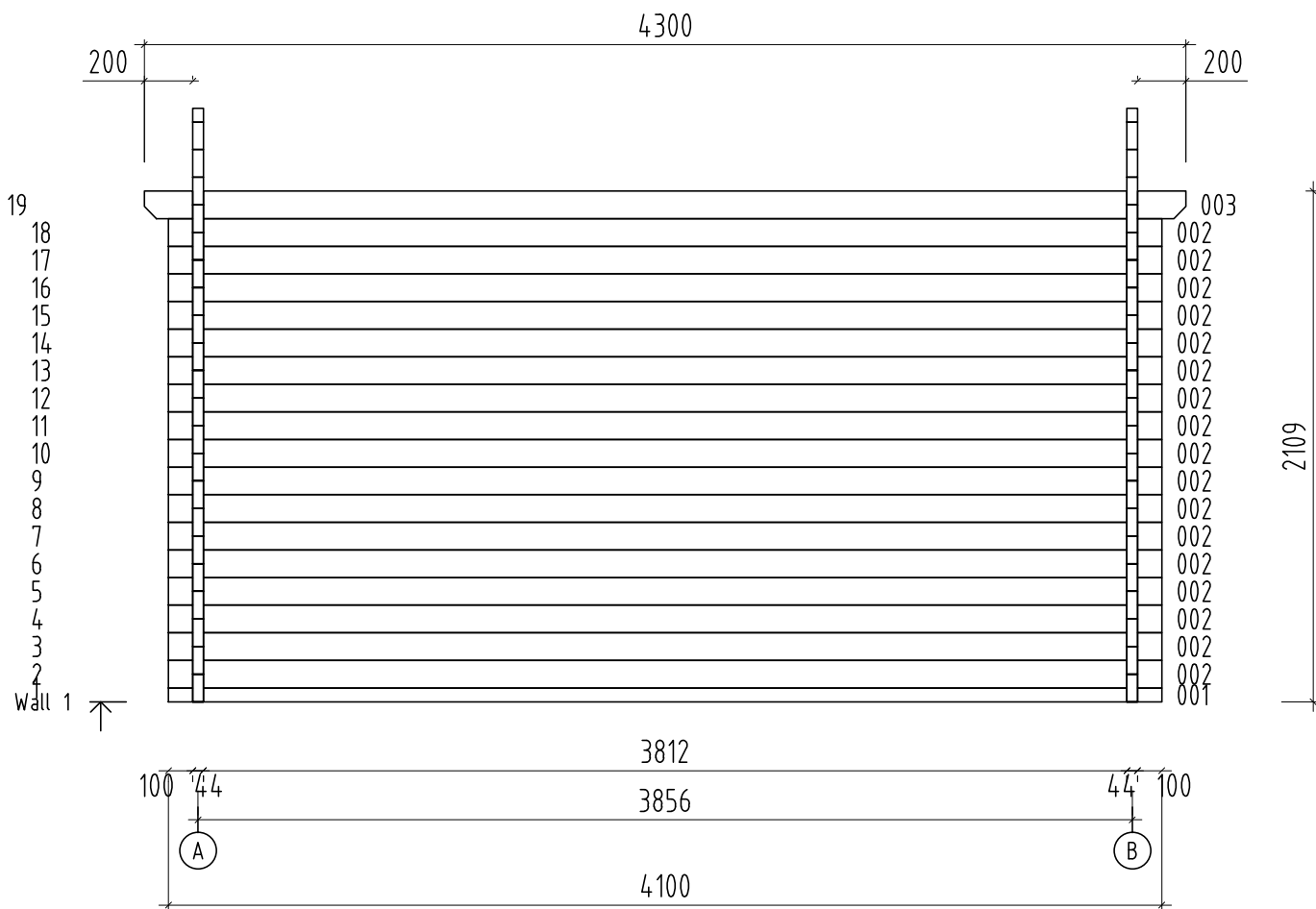



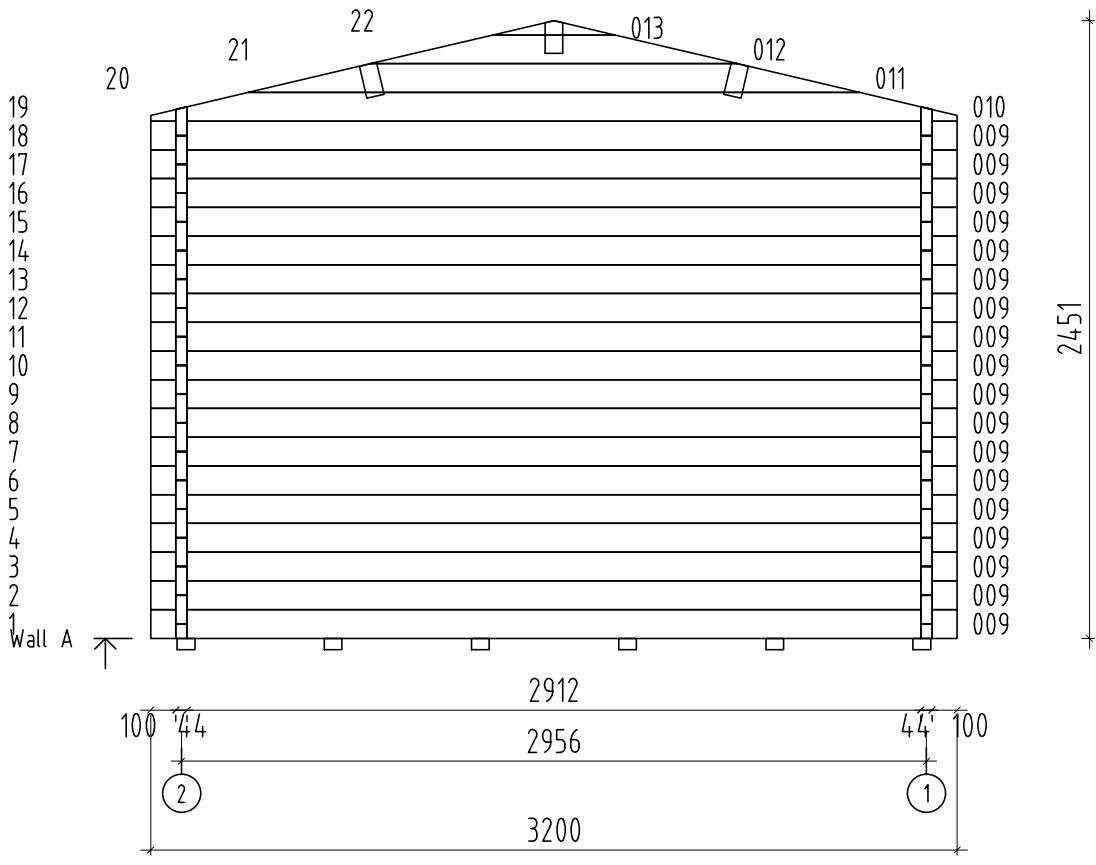

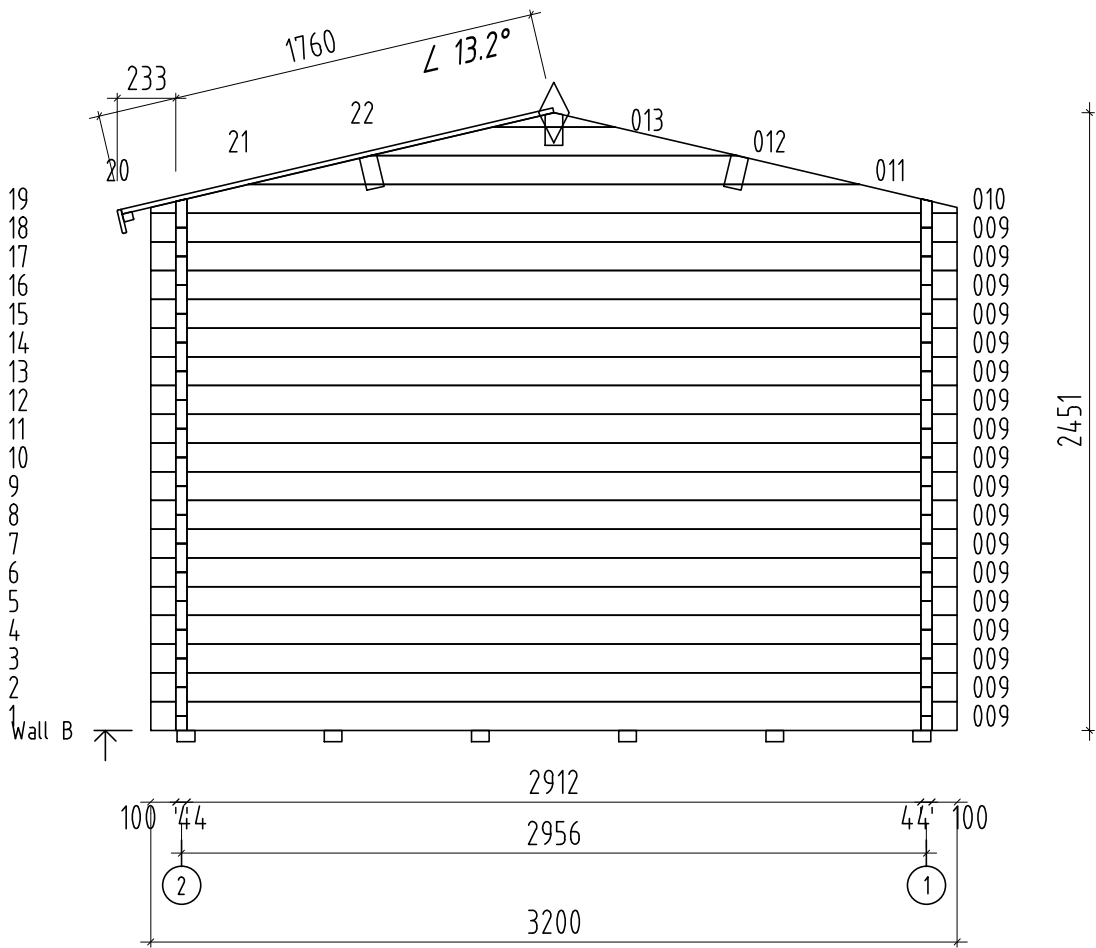

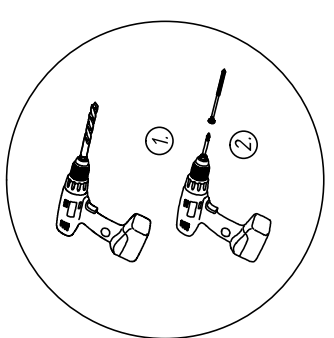
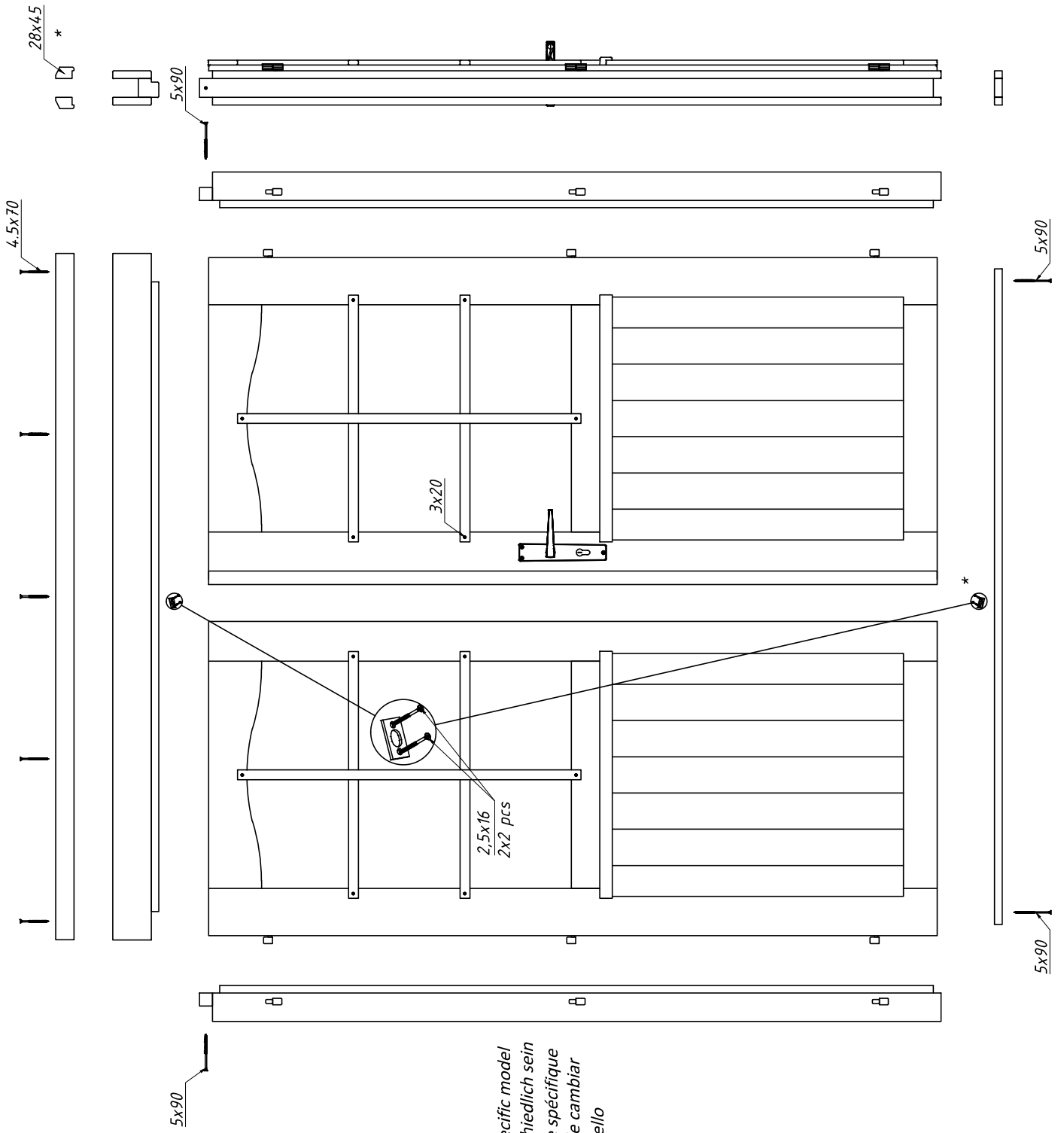

\* The specification may vary depending on the specific model  
 \* Die Spezifikation können je nach Modell unterschiedlich sein  
 \* Les spécifications peuvent varier selon le modèle spécifique  
 \* Dependiendo del modelo, la especificación puede cambiar  
 \* Le specifiche possono variare a seconda del modello