

Manual

9055914

DK/N: Læskur til dyrehold (Original)

S: Vindskydd för djur (Översättning)

D: Unterstand für Tiere (Übersetzung)

GB: Livestock Tent (Translation)

6 x 6 x 3,7 m



DK

S

D

GB

www.p-lindberg.dk
www.p-lindberg.no
www.p-lindberg.se
www.p-lindberg.de

Kontakt Danmark:

P. Lindberg A/S
Sdr. Ringvej 1
6600 Vejen
Tlf. 70 21 26 26
Fax 70 21 26 30
salg@p-lindberg.dk
www.p-lindberg.dk

Kontakt Norge:

P. Lindberg
Doneheia 62
4516 Mandal
Telefon: 21 98 47 47
hei@lindberg.no
www.p-lindberg.no

Kontakt Sverige:

P. Lindberg Sverigefilial
Myrangatan 4
745 37 Enköping
Tel. 010-209 70 50
order@p-lindberg.se
www.p-lindberg.se

Kontakt Deutschland:

P. Lindberg GmbH
Flensburger Straße 3
24969 Großenwiehe
Tel: 04604 – 9888 975
Fax: 04604 – 9888 974
kontakt@p-lindberg.de
www.p-lindberg.de

Læskur til dyrehold - Varenr. 9055914

Beskrivelse: Telt med galvaniseret stål-stel og PVC teltdug. B6 x L6 x H3,7 meter.

Anvendelsesområder: Til opbevaring af gods / maskiner, samt som læskur til dyrehold for beskyttelse mod vind & vejr, insekter, sol m.v.



VIGTIGT

Vær opmærksom på at der i nogle lande kan være krav om godkendelse til opstilling af telthaller – undersøg derfor altid med lokale myndigheder.



VIGTIGT

Sne og is kan få teltet til at kollapse. Fjern straks sne eller is, som har samlet sig fra tagkonstruktionen med en kost, moppe eller andet redskab med bløde sider. Vær ekstremt påpasselig, når der fjernes sne fra teltdugen – fjern det altid fra ydersiderne af konstruktionen – aldrig indefra! Brug ikke værktøj eller redskaber med hårde kanter såsom river og skovle for at fjerne sne. Det vil kunne lave huller i teltdugen.



Sikkerhedsinstruktioner:

Læs hede denne manual før læskuret samles. Det er meget vigtigt at læskuret forankres forsvarligt. Læskuret er kun tiltænkt som midlertidig indretning og det anbefales ikke at bruge det som en permanent indretning.

Fare:

Vælg læskurets placering med omhu.

Hold god afstand til el kabler.

Tjek for overhængende forsyningsledninger, grene og andet.

Tjek undergrunden for ledninger og rør før gravning påbegyndes.

Placer ikke læskuret tæt på tagudhæng eller andre indretninger, hvorfra der kan falde sne, is eller strømme vand ned på læskuret.

Hæng ikke genstande op i loftet eller støttekabler.



Advarsel:

Brandrisiko.

Ryg ikke og brug ikke udstyr med åbne flammer (inkl. grill, ildsted, frituregryde, rygeovne og lanterner) i eller rundt om læskuret.

Opbevar ikke brændbare væsker / gasser (som benzin, petroleum, propan etc.) i eller omkring læskuret.

Udsæt ikke læskurets tag eller sider på læskuret for åben ild eller andre flammekilder.



Pas på:

Pas på når stellet rejses. Brug sikkerhedsbriller. Fastgør og bolt overliggende stænger sammen. Pas på stængernes ender.

Før ibrugtagning:

Det anbefales at være 4+ personer om at samle læskuret.

Korrekt forankring og montering af stellet:

Det er slutbrugerens ansvar at forankre stellet ordentligt.

Sælger er ikke ansvarlig for skade på enheden eller indholdet som følge af vejrliget. Ethvert læskur, som ikke er sikkert forankret kan potentielt flyve væk og forårsage skade, som ikke vil blive dækket af garantien. Tjek jævnligt ankrene for at sikre læskurets stabilitet.

Bemærk: Teltdugen kan hurtigt fjernes og opbevares forud for dårligt vejr. Hvis stærk vind eller dårligt vejr forudsiges, anbefales det at fjerne teltdugen.

Rengøring / vedligeholdelse:

En stramtsiddende teltdug sikrer længere levetid og bedre funktion. Hold derfor altid teltdugen stram. Løst stof kan fremskynde nedbrydningen af dugen.







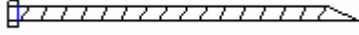

Brug ikke blegemiddel eller stærke, slibende produkter til at rengøre teltdugen med. Teltdugen rengøres let med mild sæbe og vand.

Nødvendigt værktøj til samling:

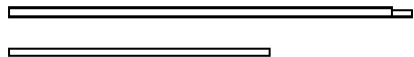

Komponenter:

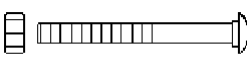
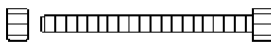
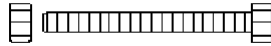
Nr.	Beskrivelse	Stk.
1	Bøjet top tværbjælke	4
2	Bøjet tag tværbjælke til midterbuerne	8
3	Bøjet tværbjælke til sidevæggene	8
4	Stolpe til for- og bagende (venstre)	2
5	Stolpe til for- og bagende (højre)	2
6	Stolpe til midterbuen	4
7	Taglægter	21
8	Portaler til bagside	2
9	Portaler til bagside	2
10	Hegn	12
11	Hegn	6
12	Stolpefødder til hjørner	4
13	Stolpefødder til midten	4

14	Stolpefødder til for- og bagende		2
15	Jordspyd		28
16	Teltdug, tag		1
17	Teltdug, endegavl		1
18	Bånd til spil		8
19	Opstrammere til tagdug		2 sæt
20	Reb til teltdug, tag		1 bundt
21	Plastikprop til pos. 19		4
22	Bolt M10x80 til taglægter		52 + 2
23	Bolt M8x70 til buerne		72 + 2
24	Bolt M10x80 til hegn		24 + 2
25	Rørclips		2

Opstilling af stel:

Trin 1: Stolpefødder og pæleplækker:

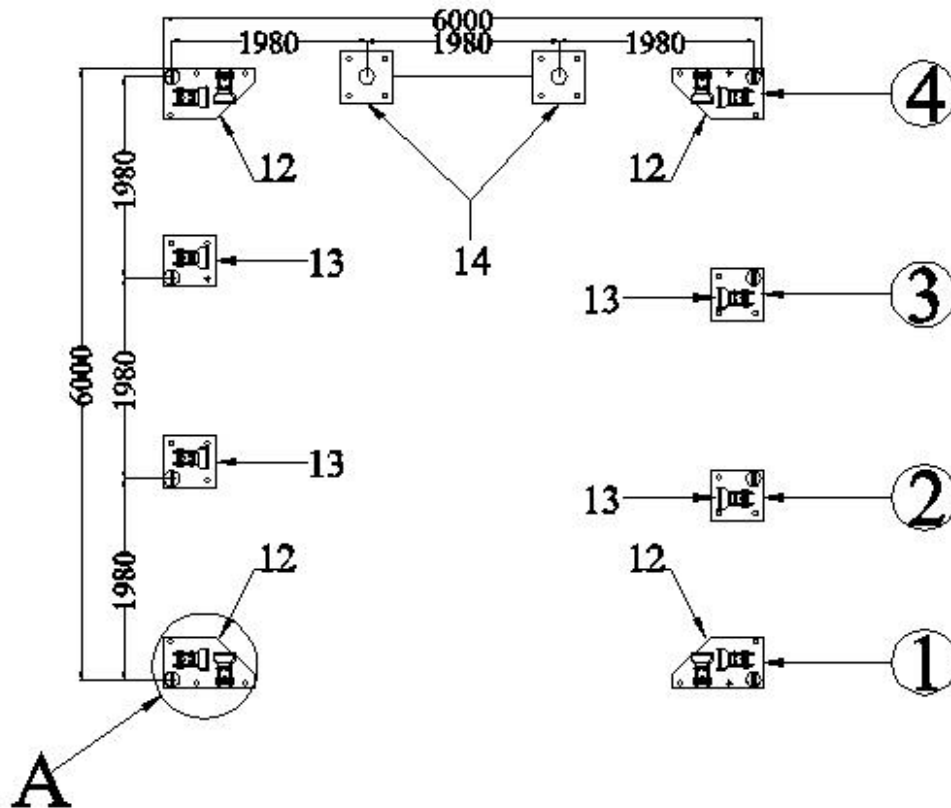

FRONT

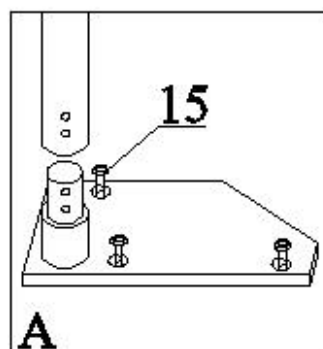
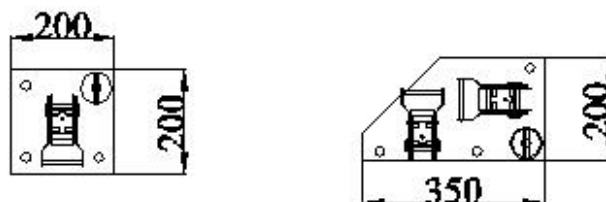

Trin 2: Den første bue (1)

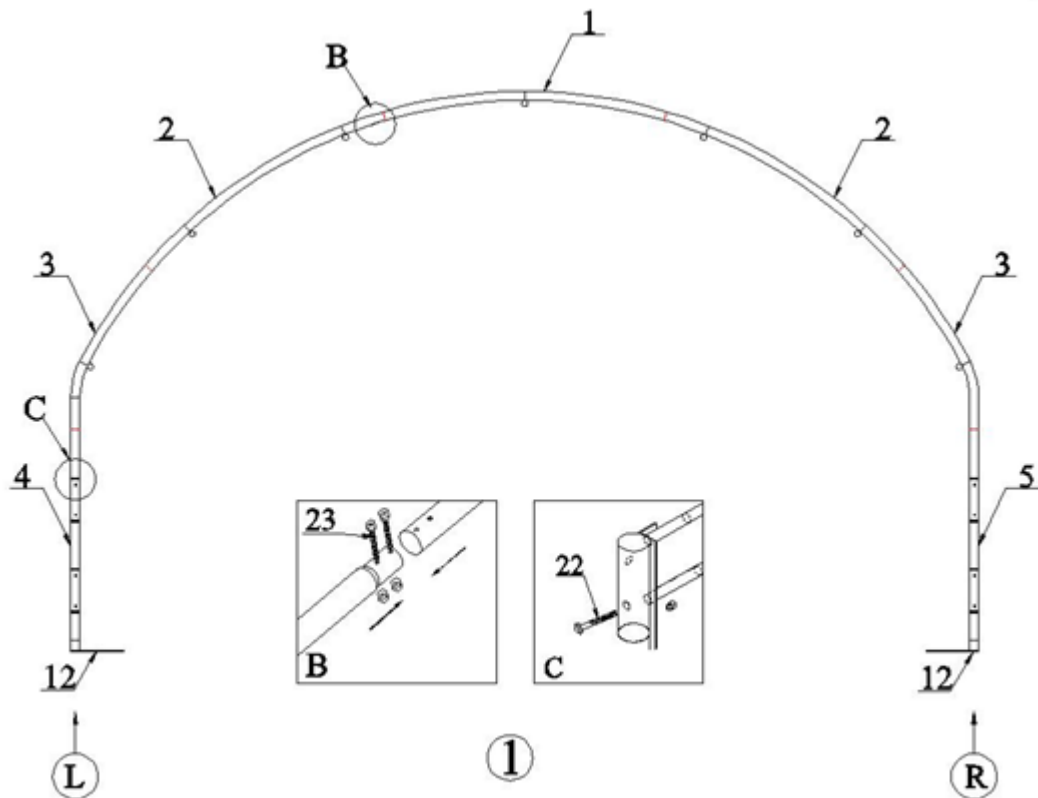

Trin 3: Midterbuerne (2 og 3)

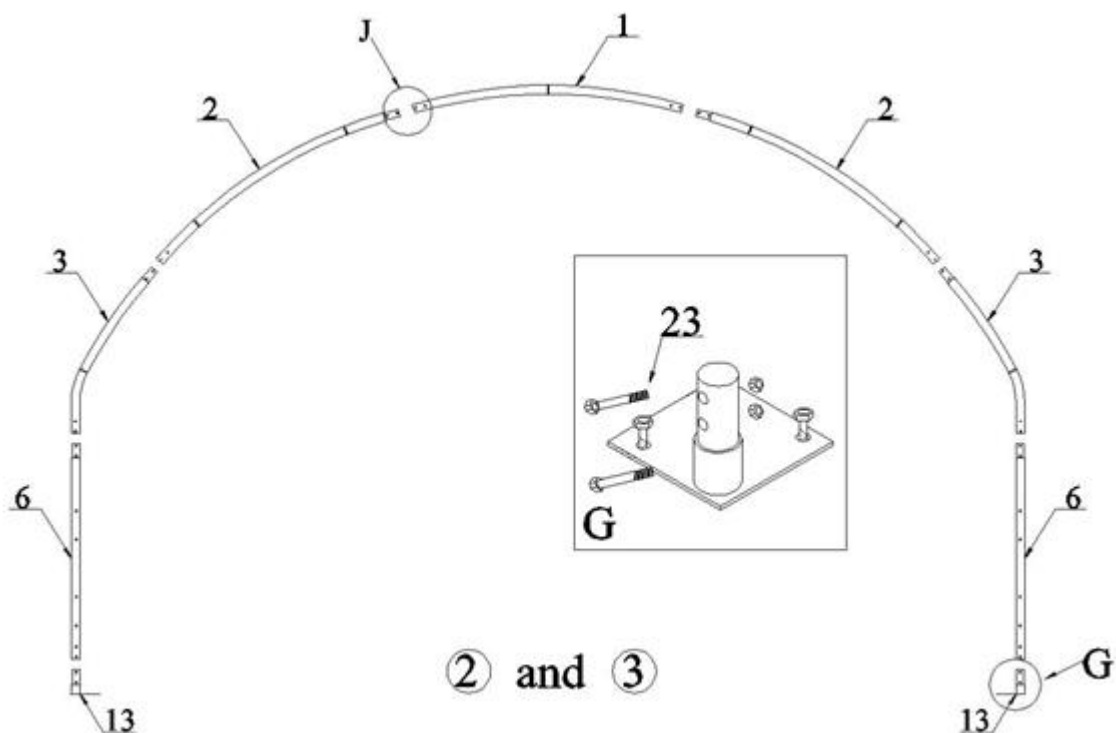

Trin 4: Den sidste bue (4), portaler og hegn

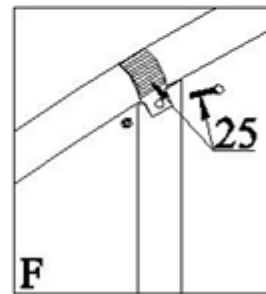
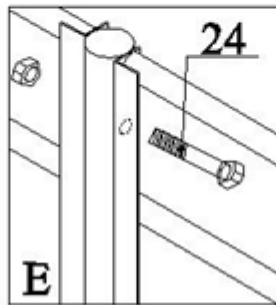
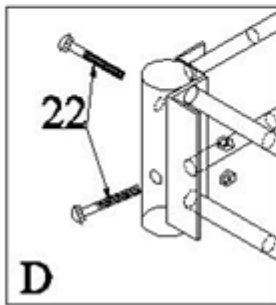
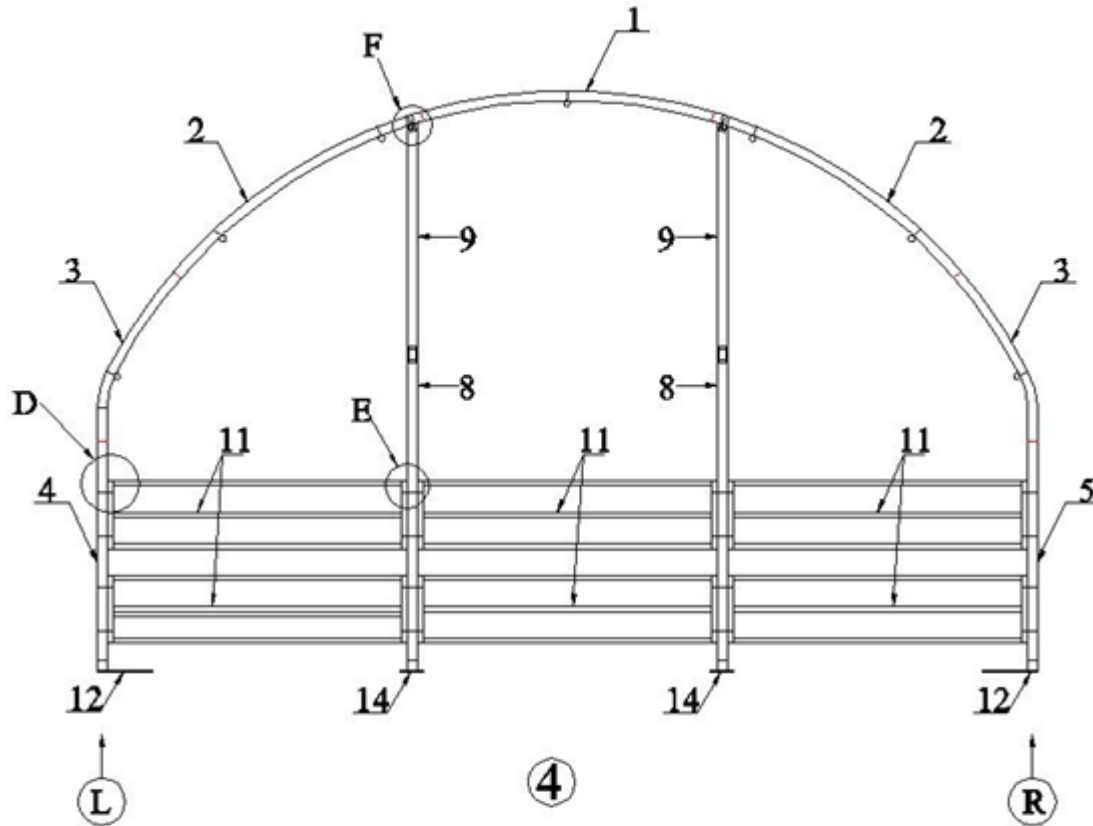

Trin 5: Lægter og sidevægge

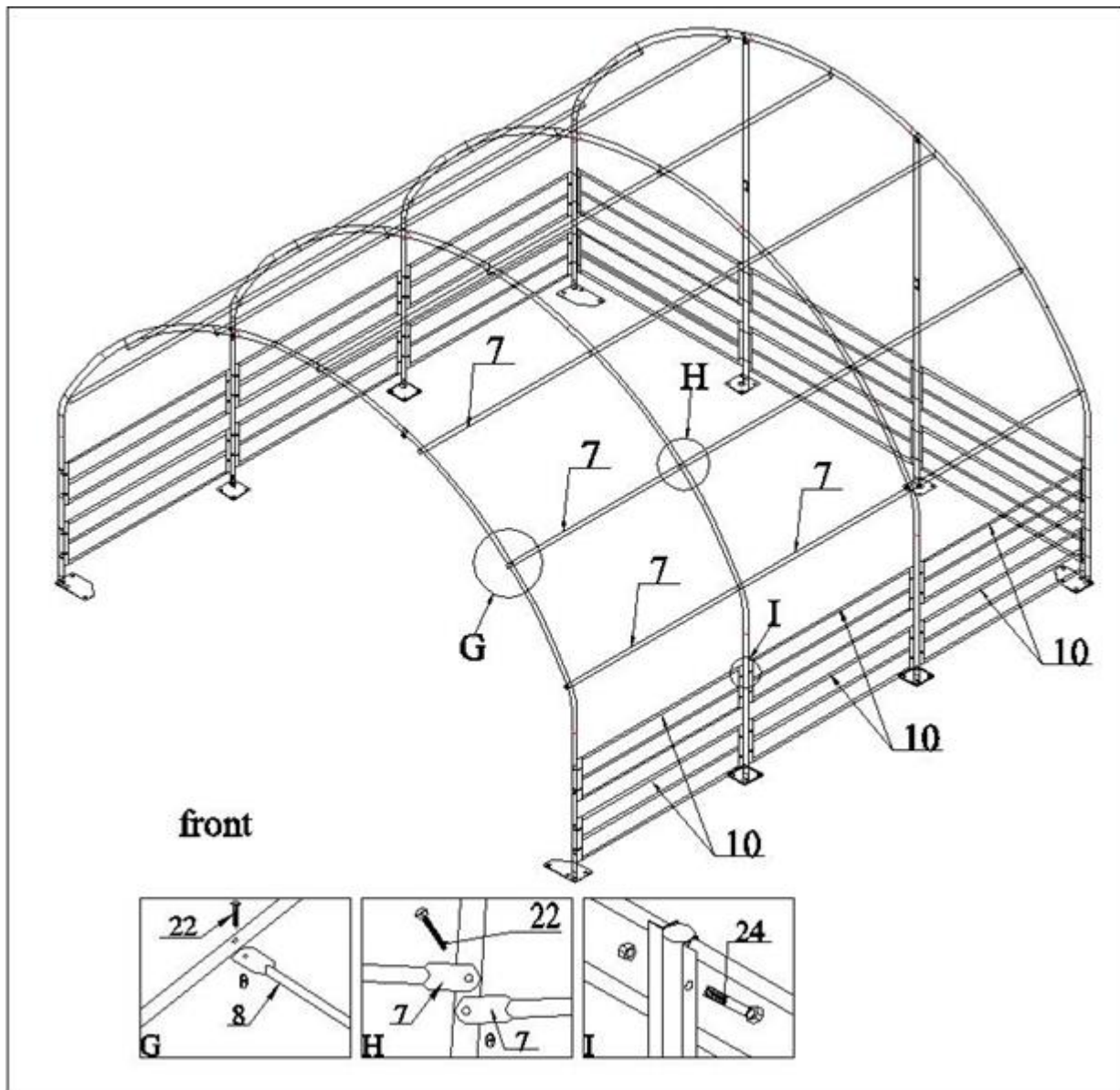

Trin 6: Opretning af stellet og sikring af stolpefødder med pælepløkker

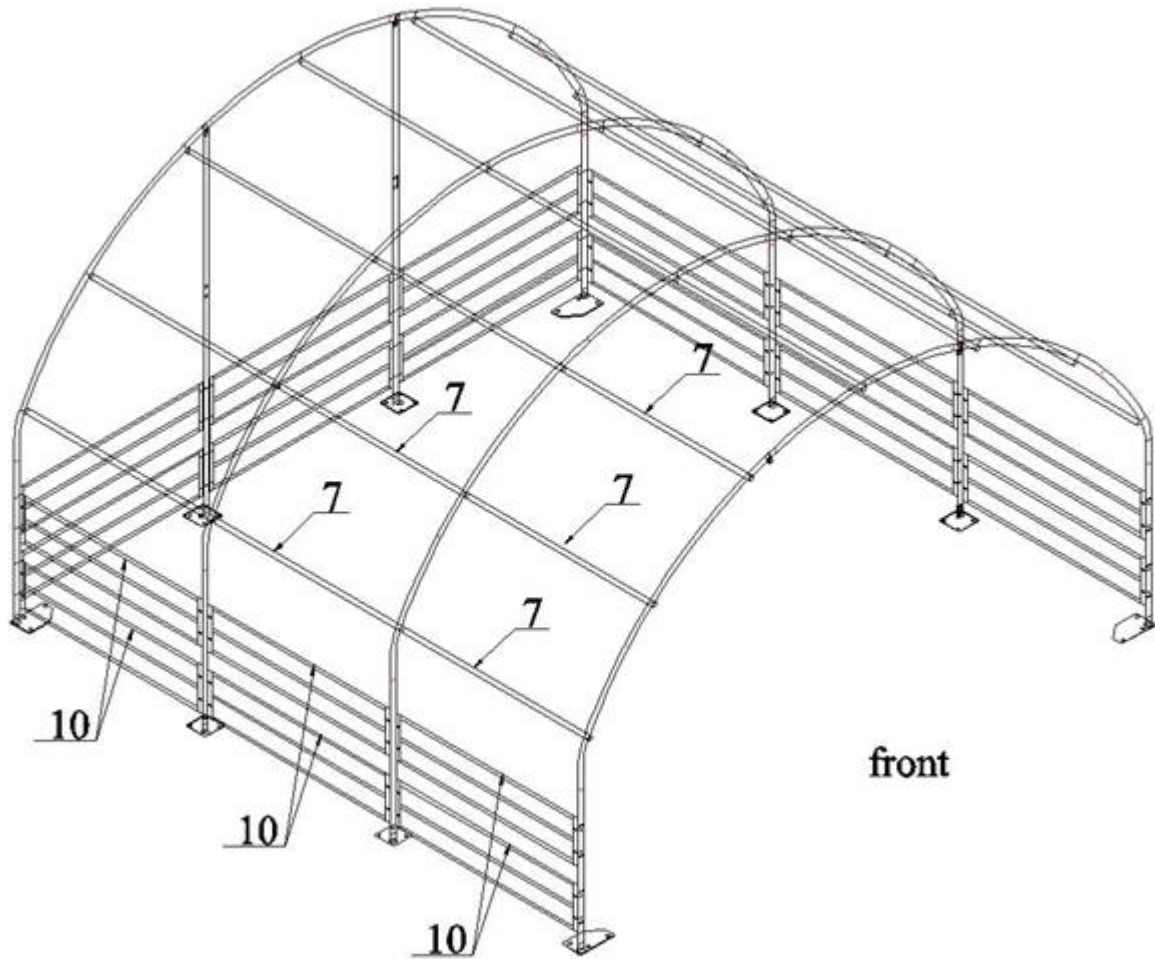

Montering af teltdug

Trin 1: Endegavl

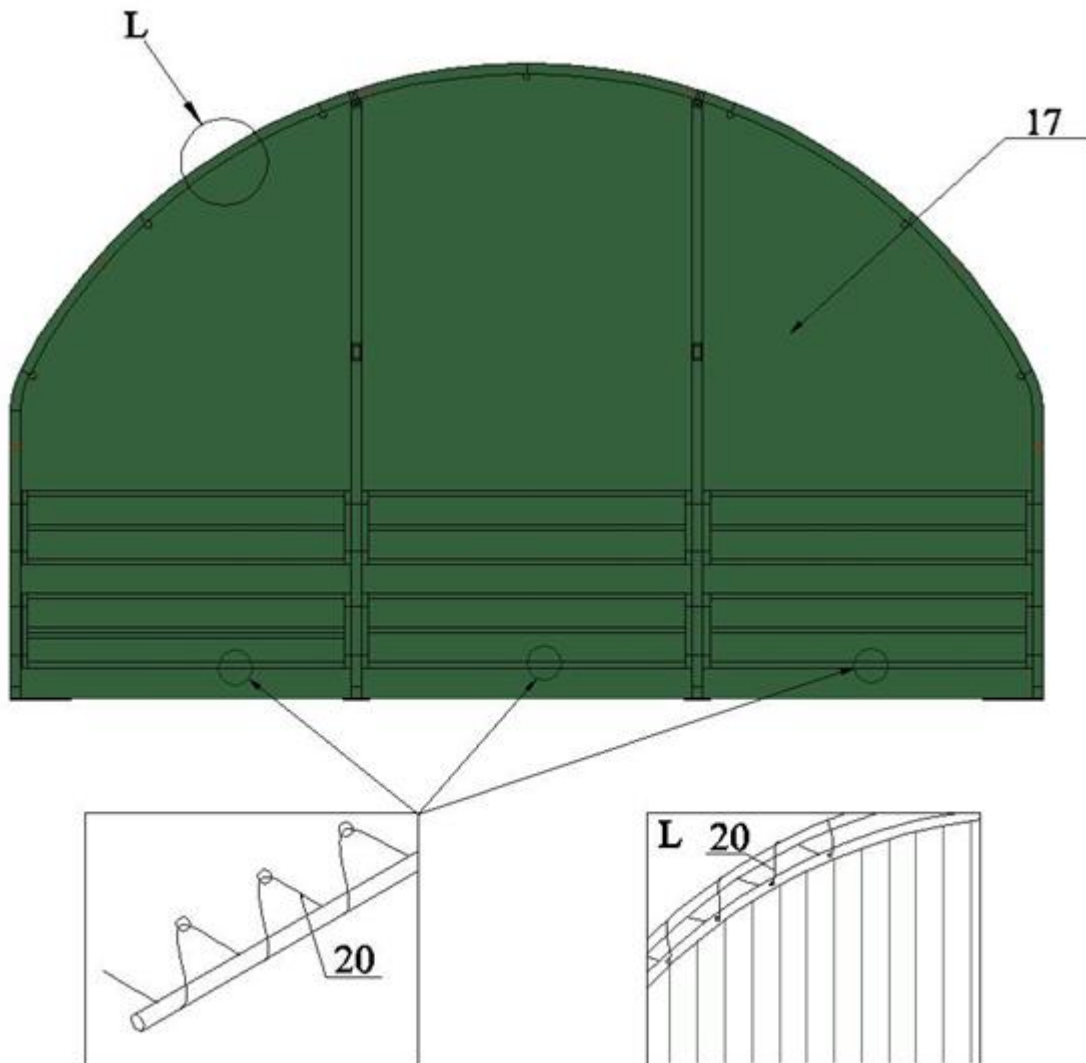

Trin 2: Taget

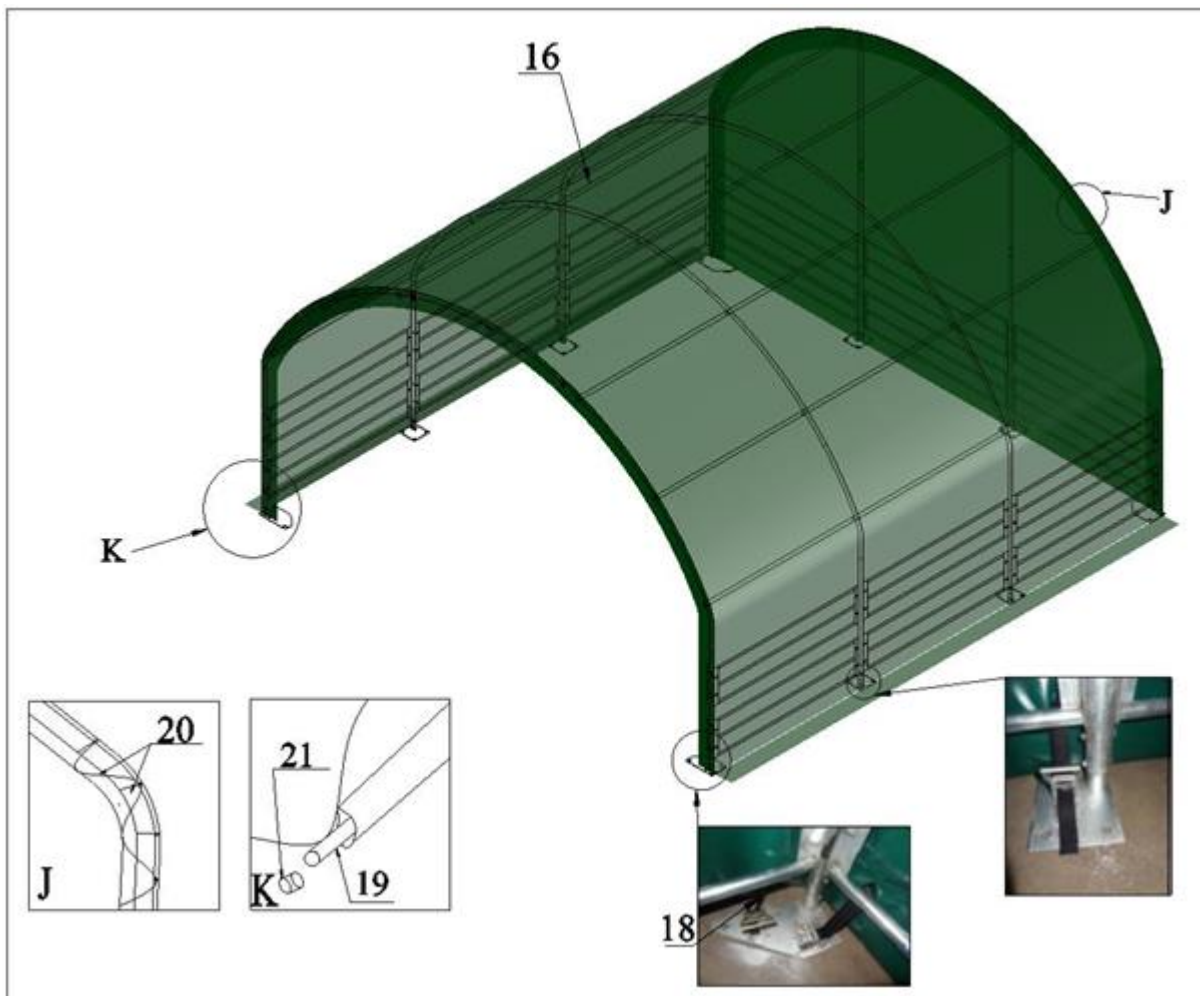

EU overensstemmelseserklæring

EU OVERENSSTEMMELSESERKLÆRING 	
Fabrikant:	P. Lindberg A/S Sdr. Ringvej 1 6600 Vejen Tlf.: 70212626 E-mail: salg@p-lindberg.dk CVR: 25903110 www.p-lindberg.dk
Erklærer herved at følgende maskine:	<i>Læskur til dyrehold (åben)</i> <i>PL varenummer 90 55 914</i>
Type / model:	SS-606
Er i overensstemmelse med følgende direktiver:	2011/305/EEC
Anvendte standarder og normer:	EN 13782:2005
Dato og ansvarlig underskrift:	Vejen d. 11-01-2022 P. Lindberg A/S  Erik T Lauritsen Direktør 

Vi forbeholder os ret til uden foregående varsel at ændre de tekniske parametre og specifikationer for dette produkt.

S

Monteringsanvisning

(Översättning av original dansk monteringsanvisning)



Vindskydd för djur – Art. 9055914

Beskrivning: Tält med galvaniserad stål-ställning och PVC tältduk.
Bredd: 6 m x Längd: 6 m x Höjd: 3,7 m.

Användningsområden: Ligghall/vindskydd för djur som skydd mot insekter, väder och sol. Passar också som förvaringshall för maskiner och gods.



VIKTIGT

Tänk på att det i vissa länder kan finnas krav på godkännande för uppförande av tälthallar – kontrollera därför alltid med dina lokala myndigheter.



VIKTIGT

Snö eller is kan få tältet att kollapsa. Avlägsna snö eller is som har fastnat på takkonstruktionen med en kvast, mopp eller annat verktyg med mjuka sidor. Var ytterst försiktig när du tar bort snö från tältet - ta alltid bort det från de yttre sidorna av strukturen - aldrig inifrån. Använd inte verktyg eller redskap med hårda kanter som krattor och spadar för att ta bort snö. Det kan göra hål i duken.



Säkerhetsinstruktioner:

Läs hela manualen innan vindskyddet monteras. Det är mycket viktigt att vindskyddet förankras ordentligt!

Fara:

Välj vindskyddets plats med omsorg.

Håll skyddet borta från elkablar.

Kontrollera om det finns luftledningar, grenar eller andra störande föremål.

Kontrollera kablar i marken och vattenrör innan grävning påbörjas.

Placera inte vindskyddet nära andra byggnader som det kan falla snö, is eller vatten från

ner på vindskyddet.

Häng inte föremål från taket.





Observera:

Brandrisk.

Rök inte och använd inte utrustningen med öppna lågor.

Förvara inte brandfarliga vätskor/gaser (såsom bensin, fotogen, propan eller liknande) i eller runt vindskyddet.

Utsätt inte vindskyddets tak eller sidor för öppen eld eller andra värmekällor.

Var försiktig när ramen ska höjas. Använd skyddsglasögon. Fäst bultar och överliggande stänger tillsammans. Akta ändarna av stängerna.

Innan användning:

Det rekommenderas att vara 4+ personer när vindskyddet monteras.

Korrekt förankring och montering av stommen:

Det är slutkundens ansvar att förankra stommen ordentligt!

Säljaren är inte ansvarig för skador på vindskyddet på grund av dåligt väder. Alla vindskydd som inte är ordentligt förankrad kan flyga iväg och orsaka skador, som inte kommer att omfattas av garantin. Kontrollera regelbundet förankringen för att vara säker

på vindskyddets stabilitet.

Observera: Tältduken kan lätt avmonteras och förvaras på annat ställe inför dåligt väder

(rekommenderas).

Rengöring/underhåll:

En åtsittande duk har längre livslängd och bättre prestanda. Därför ska duken hållas spänd. Löst tyg kan påskynda nedbrytningen av duken.







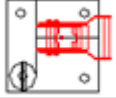

Använd inte blekmedel eller hårda slipmedel för att rengöra duken. Duken kan lätt rengöras med mild tvål och vatten.

Nödvändiga verktyg till monteringen:

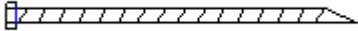

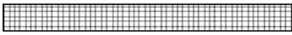
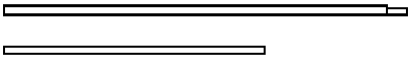
Komponenter:

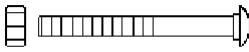
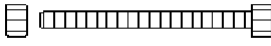
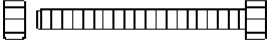
Nr.	Beskrivning	Antal.
1	Böjd tak tvärbjälke	4
2	Böjd tak tvärbjälke till mellanbåge	8
3	Böjd tvärbjälke till sidoväggarna	8
4	Stolpe till fram- och bakände (vänster)	2
5	Stolpe till fram- och bakände (höger)	2
6	Stolpe till mellandelen	4
7	Takås	21
9	Portaler till baksida	2
10	Portaler till baksida	2
12	Staket	12
13	Staket	6
16	Stolpfötter till hörn	4

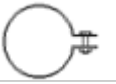
17	Stolpfötter mitten		4
18	Stolpfötter fram- och bakända		2
19	Pålpeggar		28
20	Tältduk, tak		1
22	Tältduk, ändgavel		1
23	Band till spel		8
24	Sträckare till takduk		2 set
25	Rep till tältduk, tak		1 bunt
26	Plastpropp till nr 24		4
27	Bult M10x80 till takläkt		52 + 2
28	Bult M8x70 till böjarna		72 + 2
29	Bult M10x80 till staket		24 + 2
30	Bult M8x50 till front		8
31	Rörclips		2

Uppställning av stålkonstruktion:

Fig 1: Stolpfötter och påpinnar:

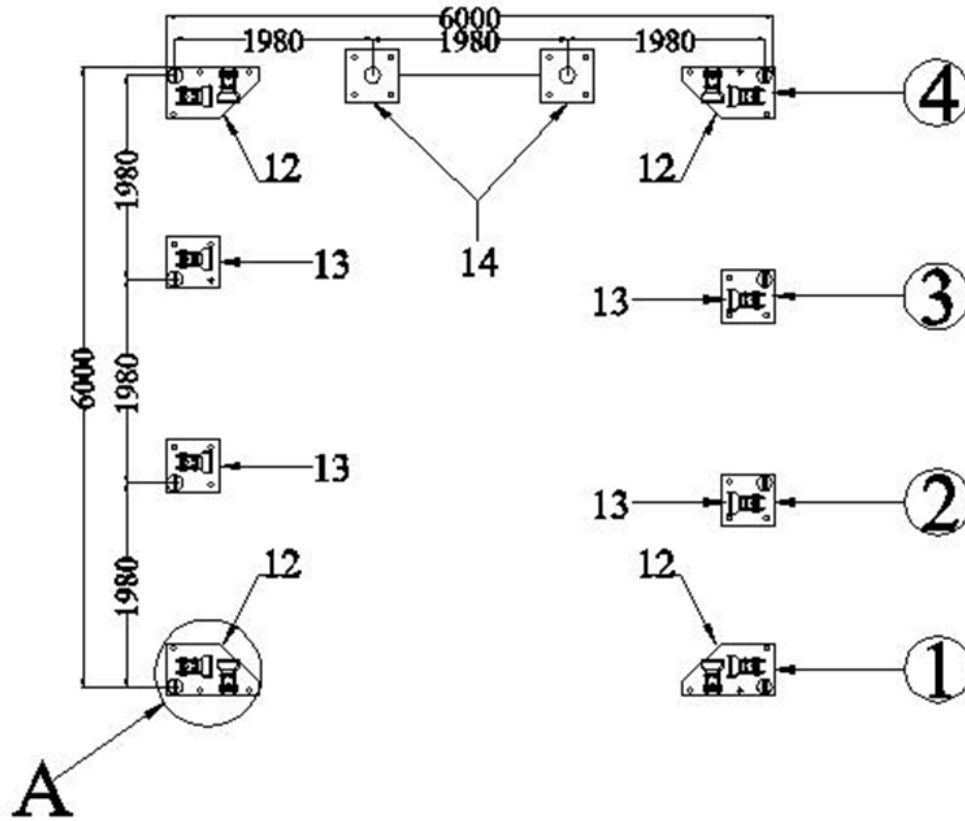

FRAM

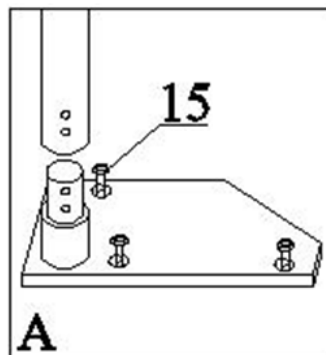
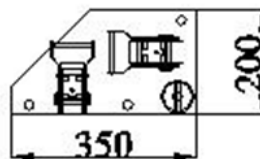
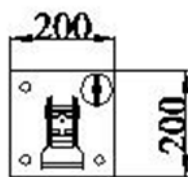

Fig 2: Den första böjen (1)

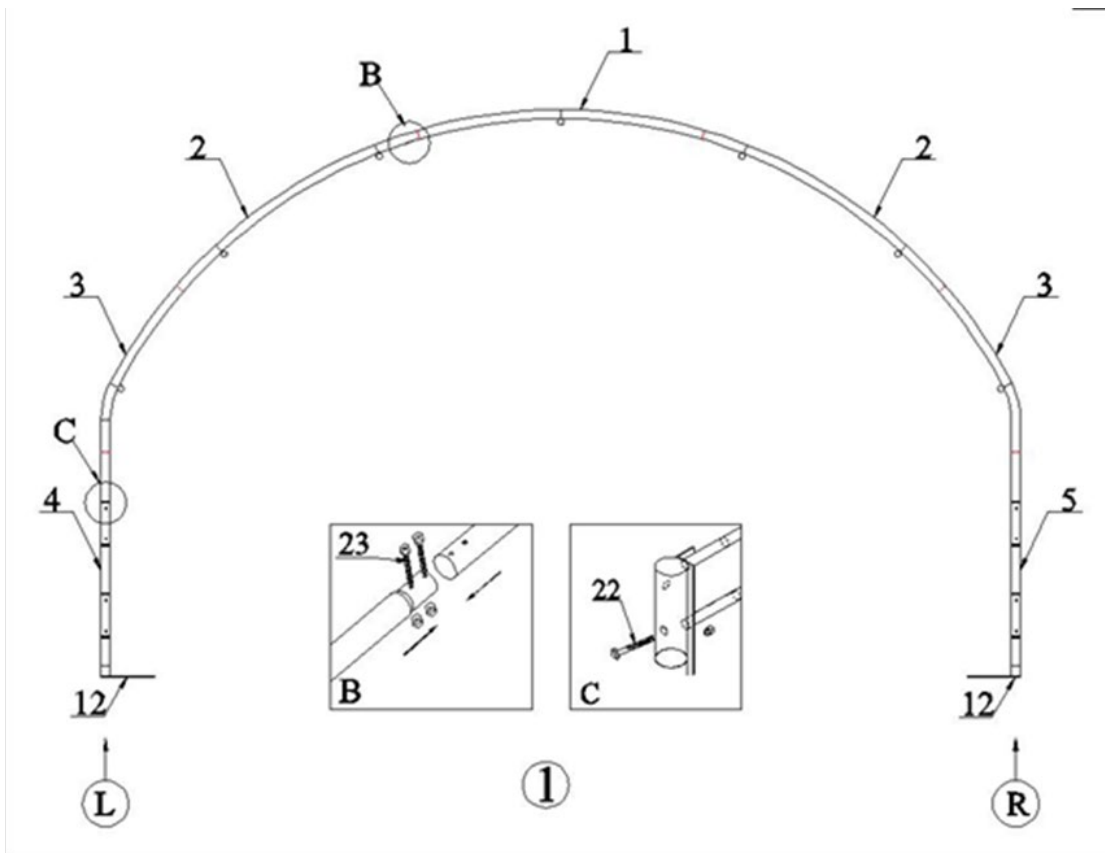

Fig 3: Mellanböjen (2 och 3)

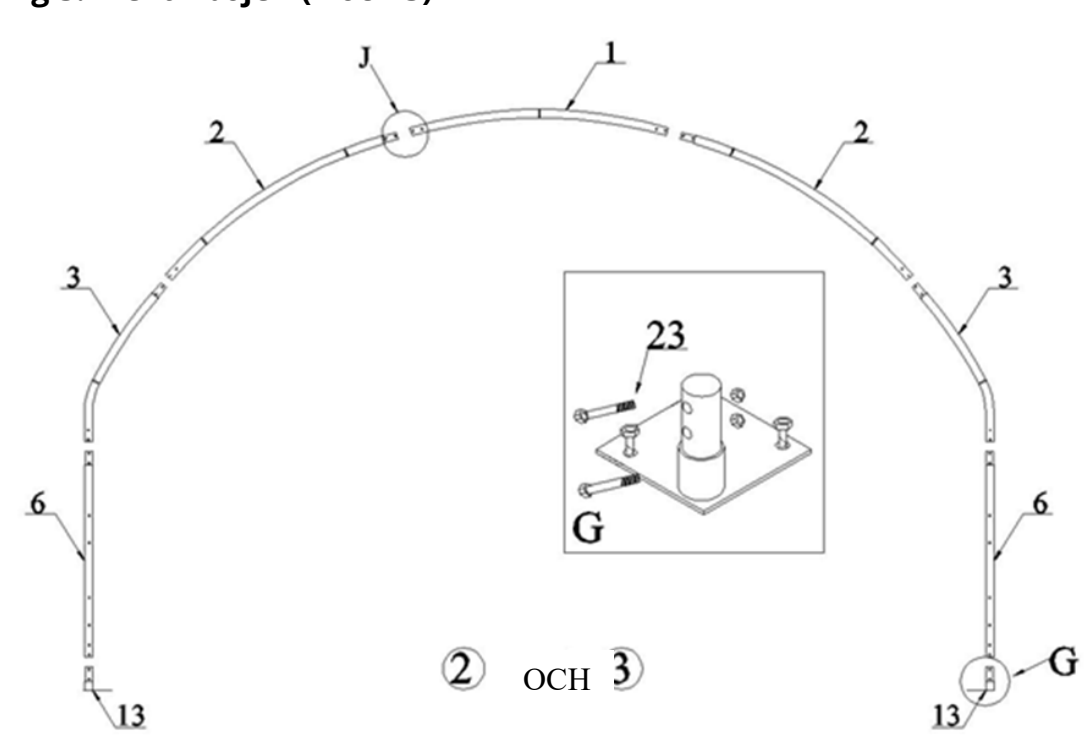

Fig 4: Den sista böjen (4), portaler och staket

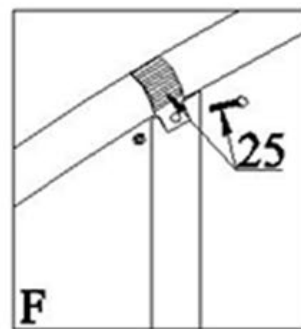
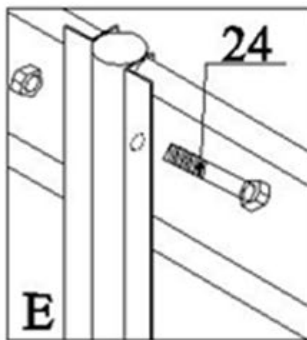
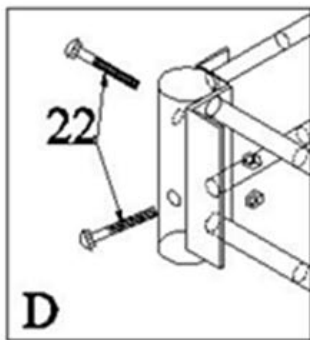
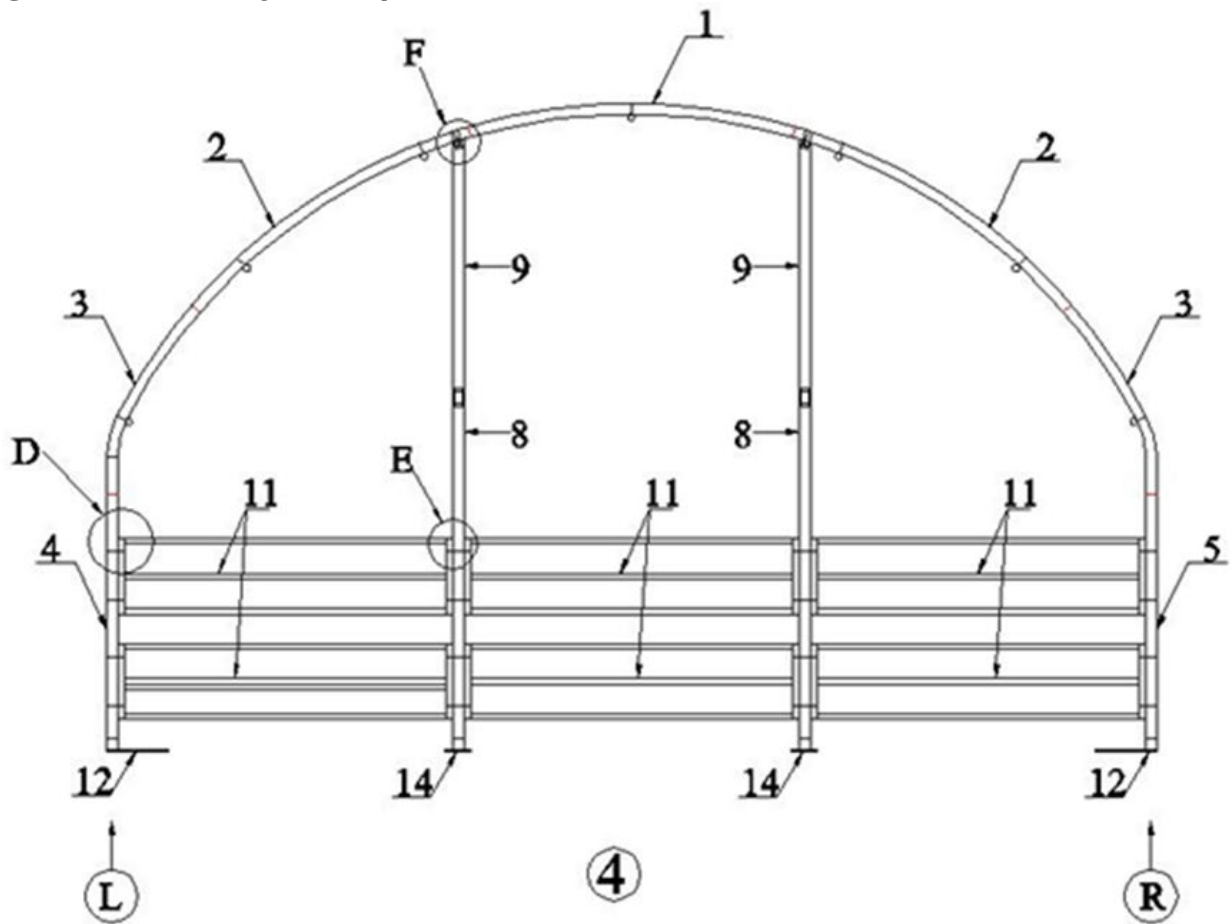

Fig 5: Läkt och sidoväggar

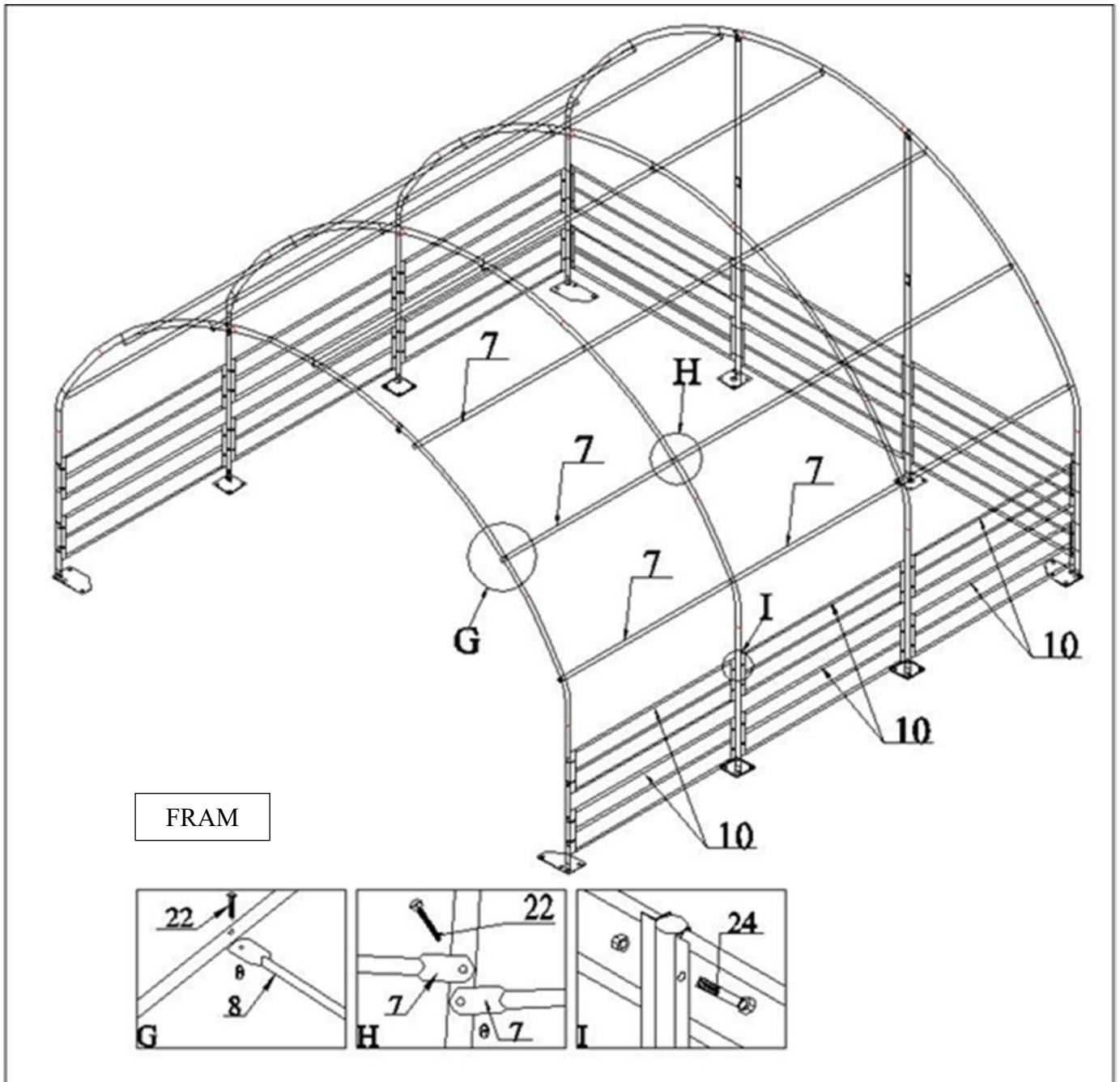
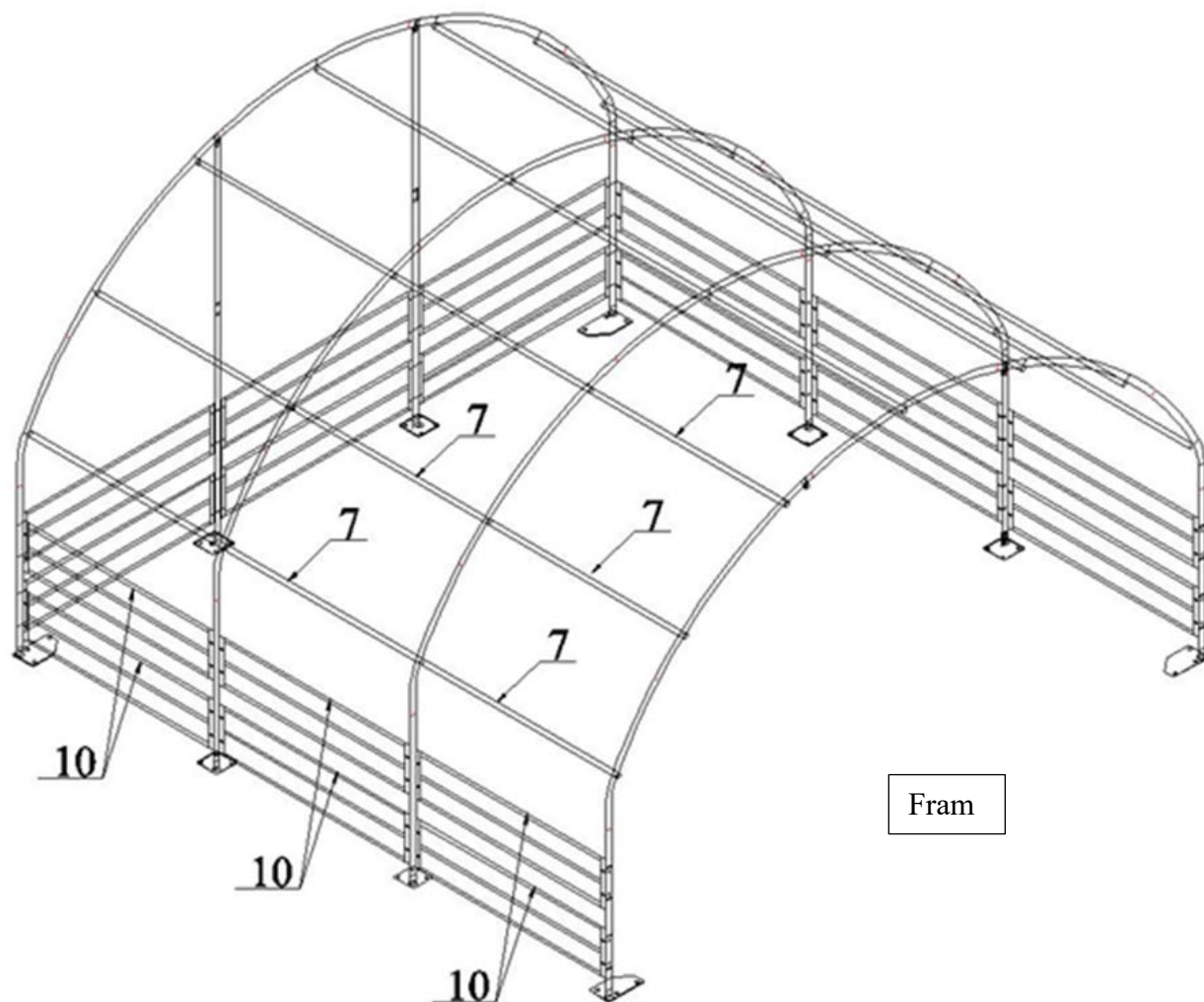

Fig 6: Uppsättning av ställning, säkring av stolpfötter med pålpinnar



Montering av tältduk

Fig 1: Ändgavel

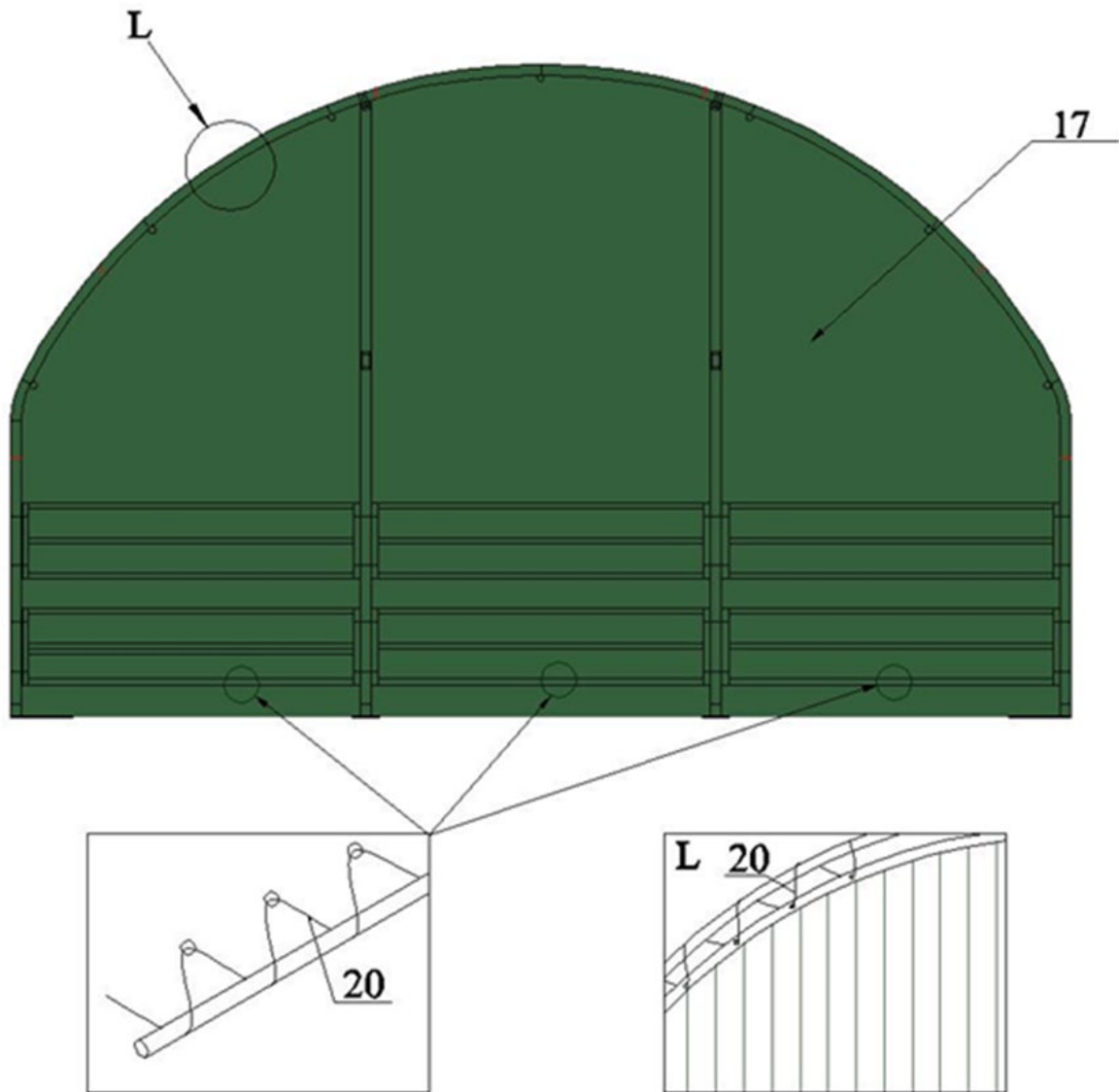
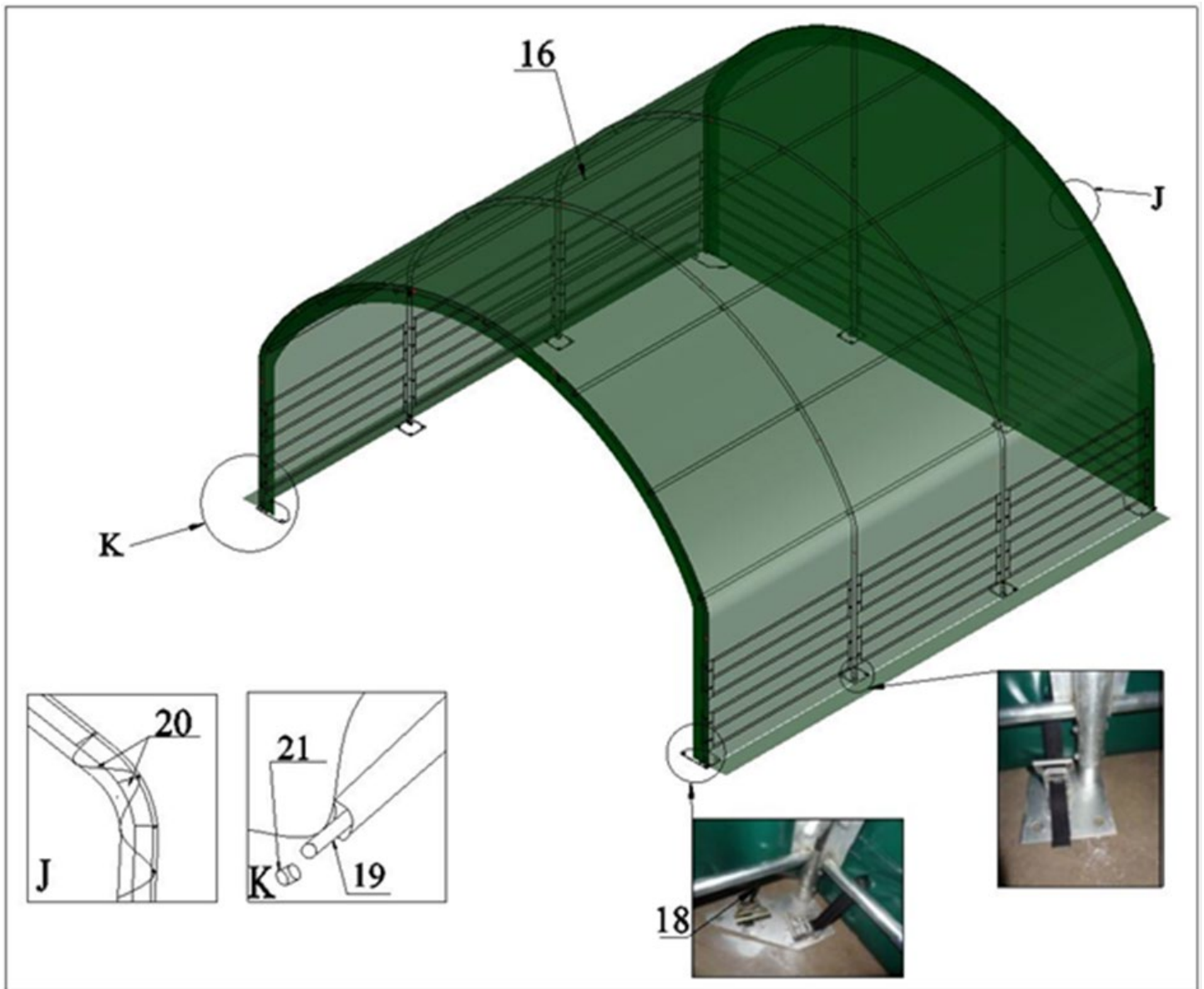

Fig 2: Taket



EU försäkran om överensstämmelse

EU-FÖRSÄKRAN OM ÖVERENSSTÄMMELSE 	
Tillverkare:	P. Lindberg A/S Sdr. Ringvej 1 DK-6600 Vejen Tlf.: +45 70212626 E-mail: salg@p-lindberg.dk CVR: 25903110 www.p-lindberg.dk
Härmed förklara att följande maskin:	Vindskydd för djur (öppen front) PL art. 90 55 914
Type / modell:	SS-606
Överensstämmer med följande direktiv:	2011/305/EEC
Tillämpade standarder och normer:	EN 13782:2005
Datum och signatur:	Vejen d. 11-01-2022 P. Lindberg A/S  Erik T Lauritsen Direktør 

Vi förbehåller oss rätten utan förvarning ändra tekniska parametrar och specifikationer för denna produkt.

D

Montageanleitung

(Übersetzung von der original dänischen Montageanleitung)



Zelthalle – Artikelnr. 9055914

Beschreibung: Zelt mit Gestell aus verzinktem Stahl und PVC-Zeltplane. B6 x L6 x H3,7 Meter.

Einsatzbereiche: Für die Aufbewahrung von Geräten/Maschinen sowie als Unterstand für Tiere zum Schutz vor Wind & Wetter, Insekten, Sonne usw.



WICHTIG

Beachten Sie, dass in einigen Ländern Genehmigungspflichten für das Aufstellen von Zelthallen bestehen können - fragen Sie daher immer bei den örtlichen Behörden nach.



WICHTIG

Schnee und Eis können das Zelt zum Einsturz bringen. Entfernen Sie Schnee oder Eis, das sich am Dach gesammelt hat, sofort mit einem Besen, Mopp oder einem anderen Gerät mit einem weichen Ende. Seien Sie beim Entfernen von Schnee von der Zeltplane extrem vorsichtig. Entfernen Sie es immer von der Außenseite der Konstruktion - niemals von der Innenseite! Verwenden Sie kein Werkzeug und keine Geräte mit scharfen Kanten wie Rechen oder Schaufeln zum Entfernen von Schnee. Dies könnte Löcher in die Zeltplane machen.



Sicherheitsanweisungen:

Lesen Sie vor dem Aufbau der Zelthalle das gesamte Handbuch. Es ist wirklich wichtig, dass die Halle angemessen verankert wird. Die Halle ist lediglich als Übergangslösung gedacht. Es wird empfohlen, diese nicht als dauerhafte Lösung zu verwenden.

Gefahr:

Wählen Sie die Platzierung des Unterstands sorgfältig.

Halten Sie ausreichend Abstand zu Stromkabeln.

Überprüfen Sie, dass keine überhängenden Versorgungsleitungen, Zweige oder Sonstiges im Weg sind.

Überprüfen Sie den Boden auf Leitungen und Rohre hin, bevor mit den Grabungsarbeiten begonnen wird.

Stellen Sie den Unterstand nicht in der Nähe von Dachvorsprüngen oder anderen Elementen auf, von denen Schnee oder Eis fallen oder Wasser auf den Unterstand fließen kann.



Hängen Sie keine Gegenstände an die Decke oder die Stützkabel.

Warnung:

Brandgefahr.

Rauchen Sie nicht und verwenden Sie keine Geräte mit offenen Flammen (inkl. Grill, Feuerstelle, Fritteuse, Räucheröfen und Laternen) im oder in der Nähe des Unterstands.



Bewahren Sie im oder in der Nähe des Unterstands keine brennbaren Flüssigkeiten/Gase (wie Benzin, Petroleum, Propan usw.) aus.

Das Dach und die Seiten des Unterstands dürfen offenem Feuer oder anderen Zündquellen nicht ausgesetzt werden.

ACHTUNG:

Seien Sie vorsichtig, wenn Sie das Gestell aufstellen. Verwenden Sie Sicherheitsbrillen. Schrauben Sie übereinander liegende Stangen zusammen. Passen Sie auf die Enden der Stangen auf.

Vor der Inbetriebnahme:

Es wird empfohlen, dass mindestens 4 Personen den Aufbau des Unterstands durchführen.

Richtige Verankerung und Montage des Gestells:

Der Endverbraucher trägt die Verantwortung dafür, das Gestell ordentlich zu verankern.

Der Verkäufer ist nicht verantwortlich für Schäden am Unterstand oder den gelagerten Gegenständen aufgrund des Wetters. Jeder Unterstand, der nicht sicher verankert ist und potenziell wegfliegen und Schäden verursachen kann, ist von der Garantie ausgeschlossen. Kontrollieren Sie die Verankerung regelmäßig, um die Stabilität zu prüfen.

Hinweis: Die Zeltplane kann vor schlechtem Wetter rasch entfernt und aufbewahrt werden. Es wird empfohlen, die Zeltplane vor schlechtem Wetter oder starkem Wind zu entfernen.

Reinigung/Wartung:



Eine straff sitzende Zeltplane bedeutet eine längere Lebensdauer und eine bessere Funktion. Sorgen Sie daher stets dafür, dass die Zeltplane straff ist. Loser Stoff kann die Abnutzung der Plane erhöhen.







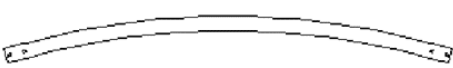
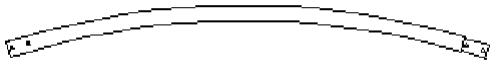
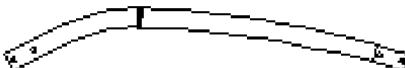
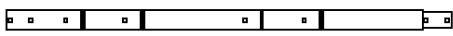
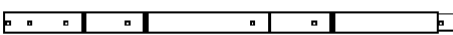
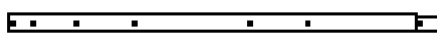
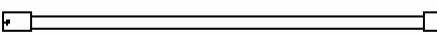
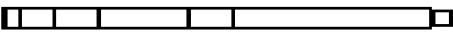



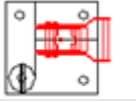

Verwenden Sie keine Bleichmittel oder starke Scheuerprodukte zum Reinigen der Zeltplane. Die Zeltplane wird vorsichtig mit milder Seife und Wasser gereinigt.

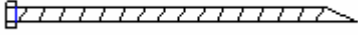
Für den Zusammenbau notwendiges Werkzeug:

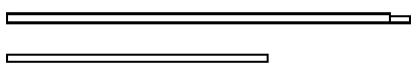

Komponenten:

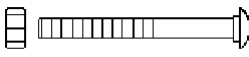
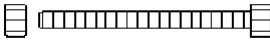
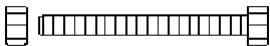
Nr.	Beschreibung		Stk.
1	Gebogener Querbalken oben		4
2	Gebogener Querbalken oben für		8
3	Gebogener Querbalken für Seitenwand		8
4	Stütze für vorne und hinten (links)		2
5	Stütze für vorne und hinten (rechts)		2
6	Stütze für mittleren Bogen		4
7	Dachlatten		21
8	Öffnung hinten		2
9	Öffnung hinten		2
10	Zaun		12

11	Zaun		6
12	Stützenfüße für Ecken		4
13	Stützenfüße für die Mitte		4
14	Stützenfüße für vorne und hinten		2
15	Anker		28
16	Zeltplane, Dach		1
17	Zeltplane, Endgiebel		1
18	Seil für Winde		8
19	Spanner für Zeltplane		2 Sets
20	Seil für Zeltplane, Dach		1 Bund
21	Kunststoffstöpsel für Pos. 19		4
22	Schraube M10x80 für Dachlatten		52 + 2
23	Schraube M8x70 für Bögen		72 + 2
24	Schraube M10x80 für Zaun		24 + 2
25	Rohrclips		2

Aufstellen des Gestells:

Schritt 1: Stützenfüße und Anker:

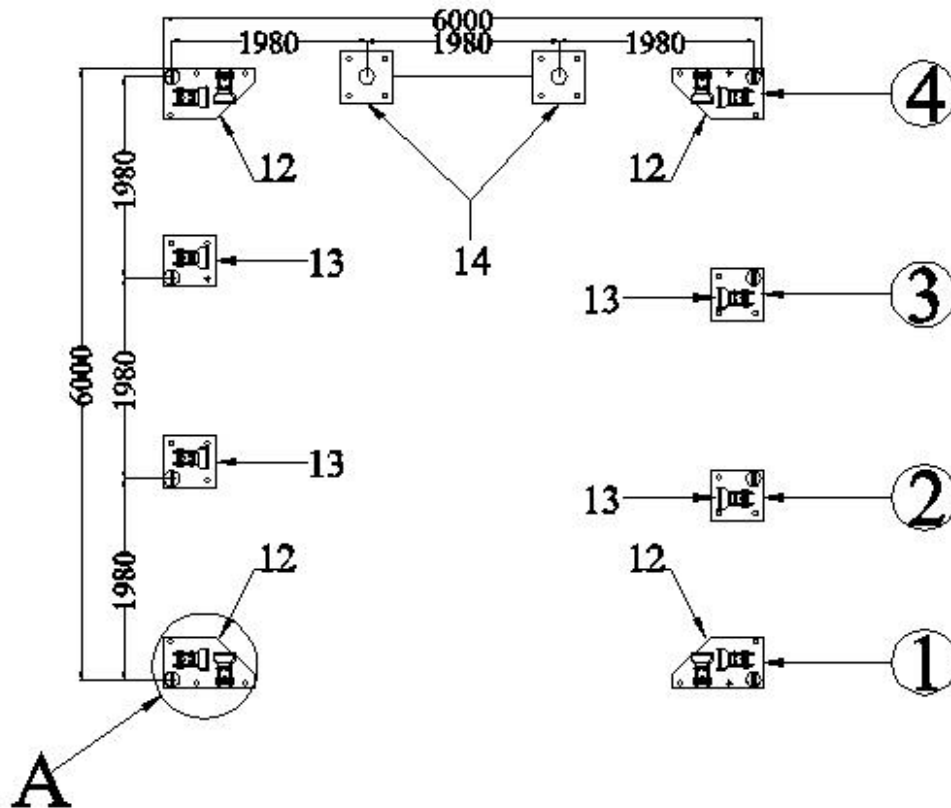

FRONT

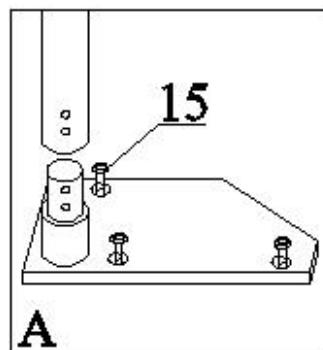
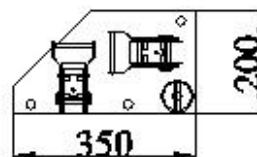
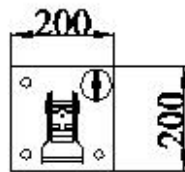

Schritt 2: Der erste Bogen (1)

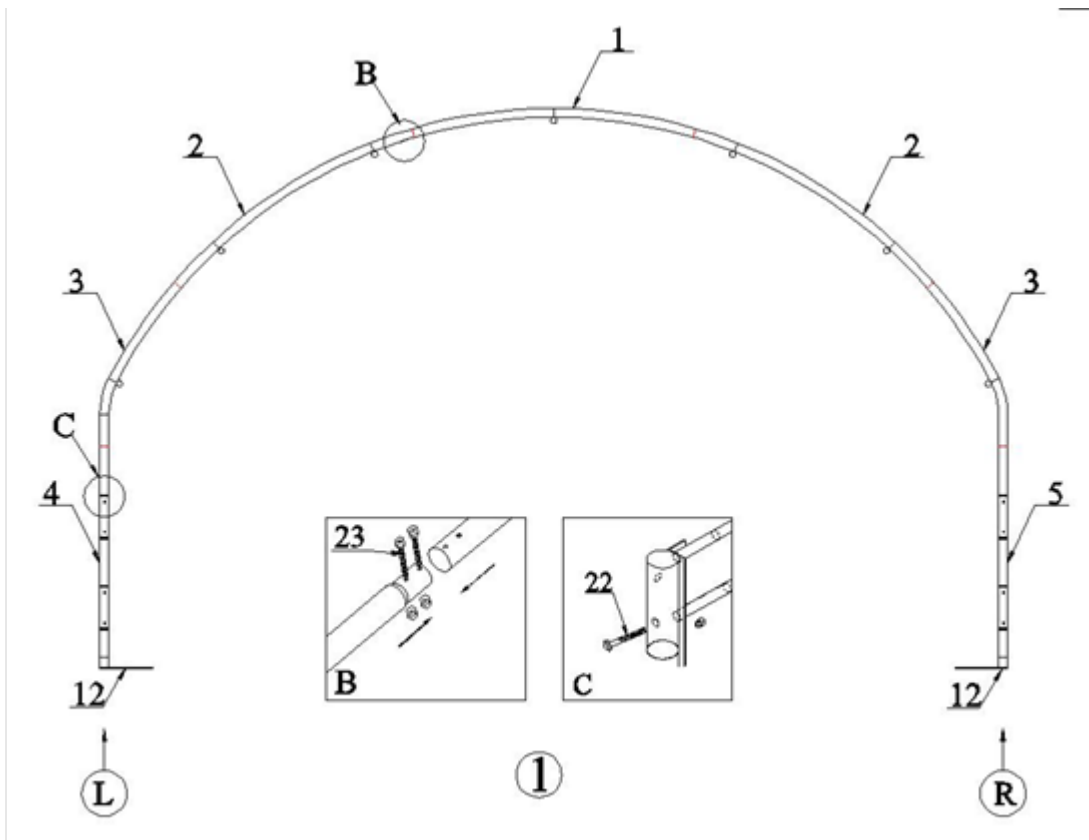

Schritt 3: Mittlere Bögen (2 und 3)

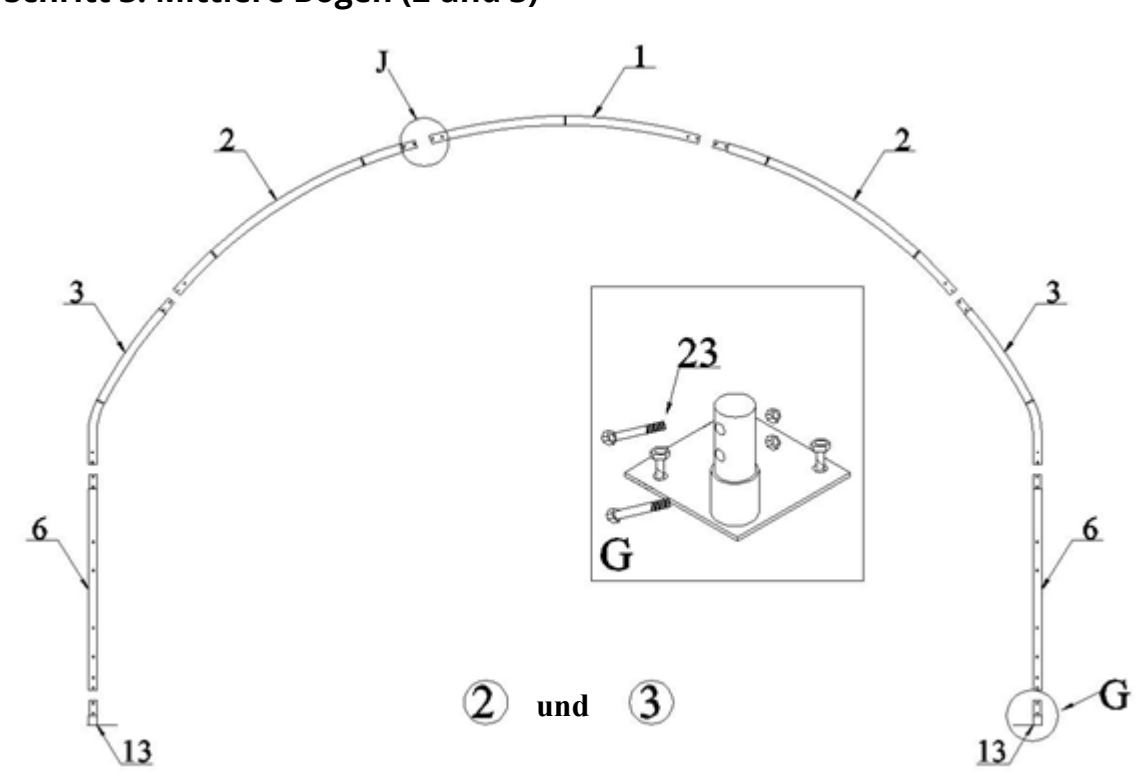

Schritt 4: Der letzte Bogen (4), Öffnungen und Zaun

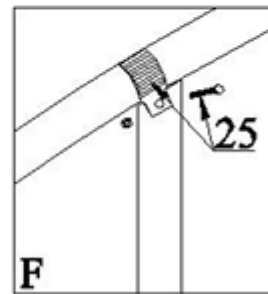
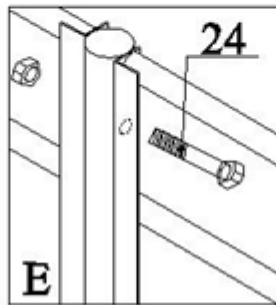
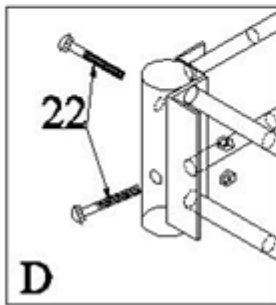
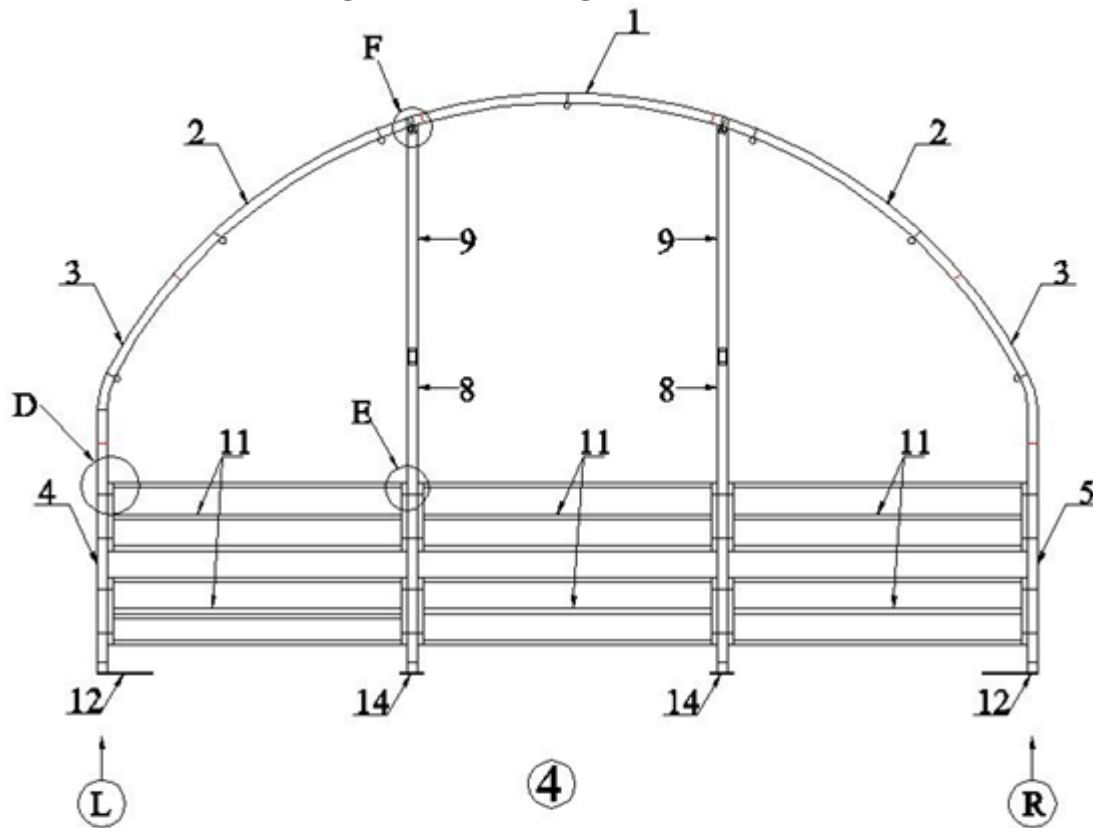

Schritt 5: Latten und Seitenwände

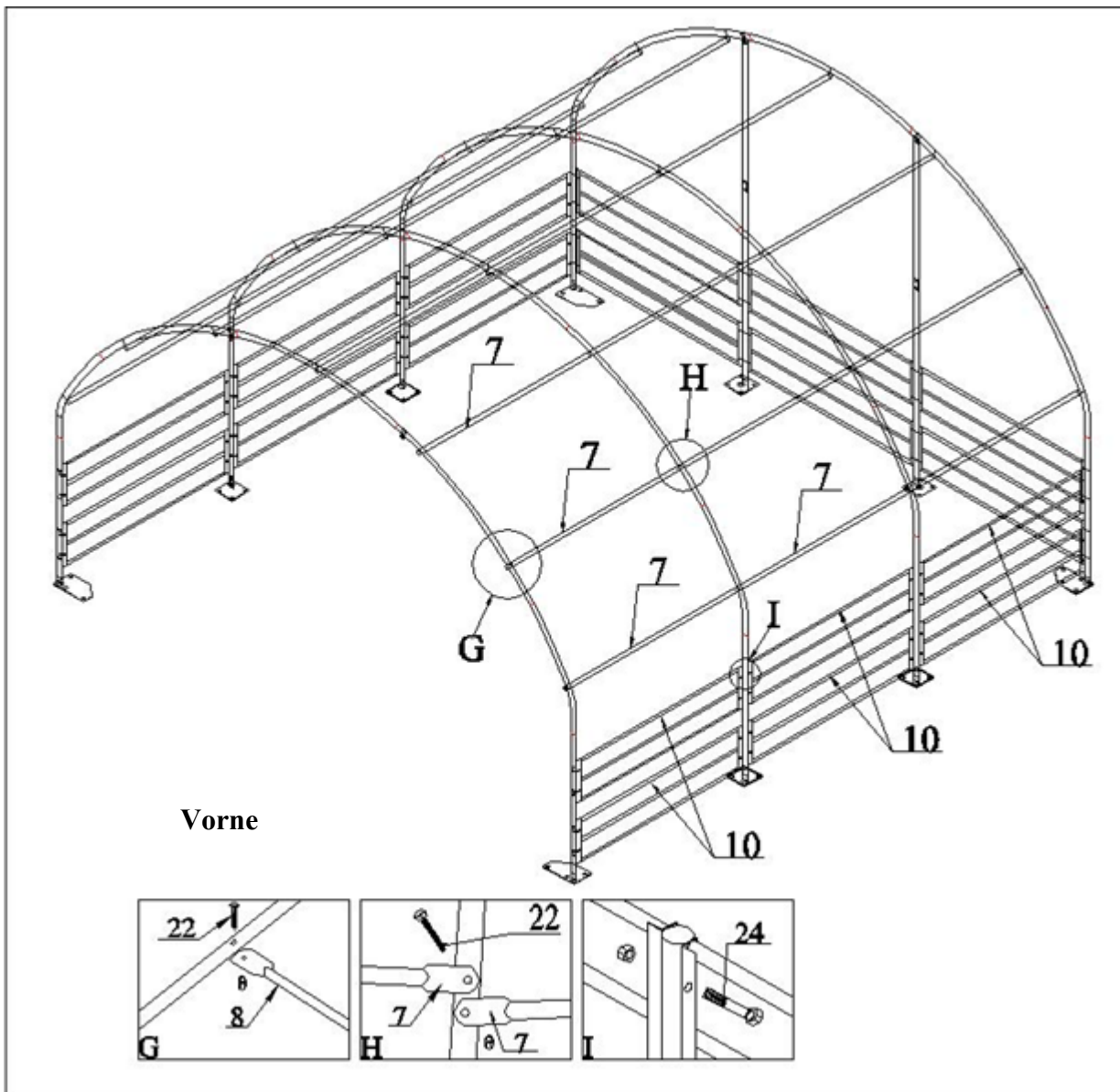

Schritt 6: Anpassen des Gestells und Sicherung der Stützenfüße mit Ankern

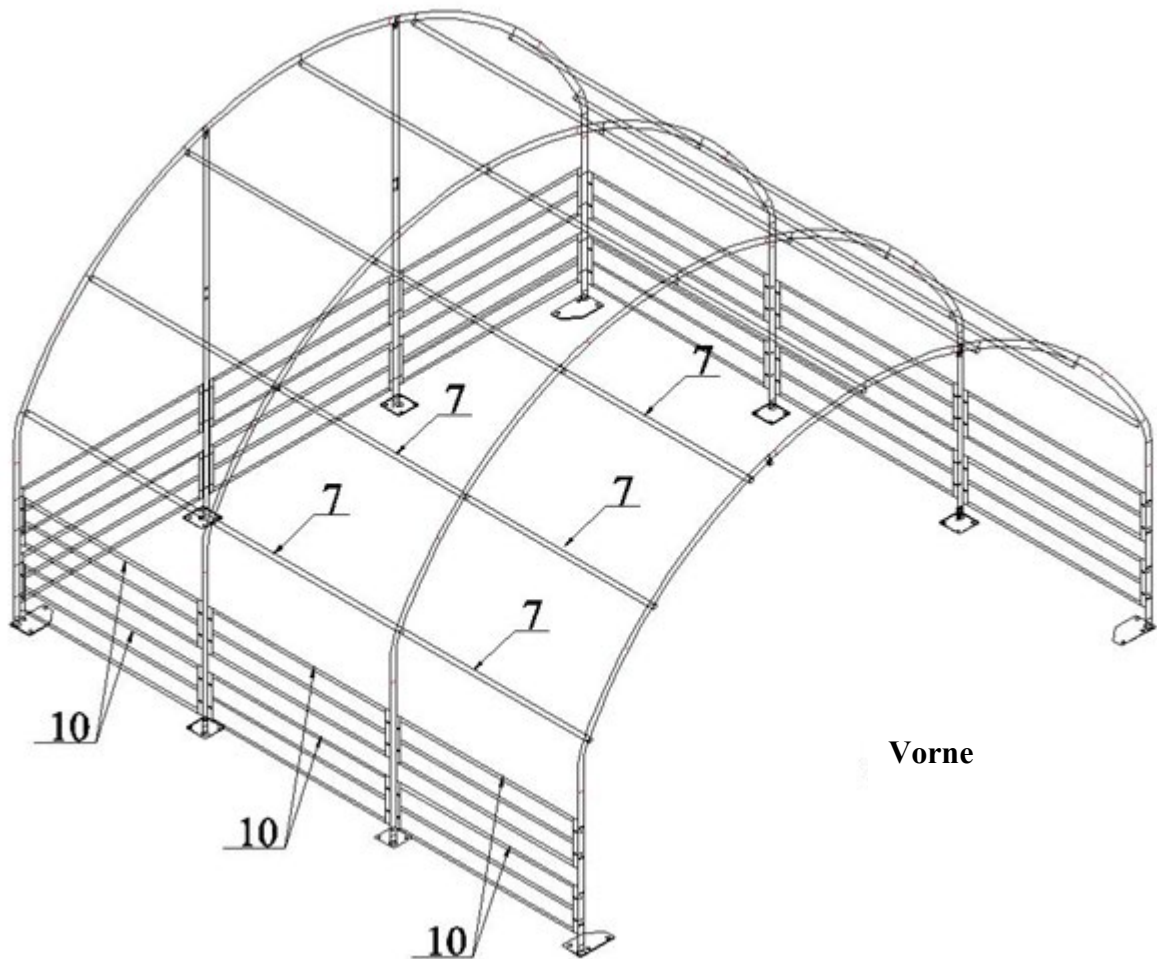

Montage der Zeltplane

Schritt 1: Endgiebel

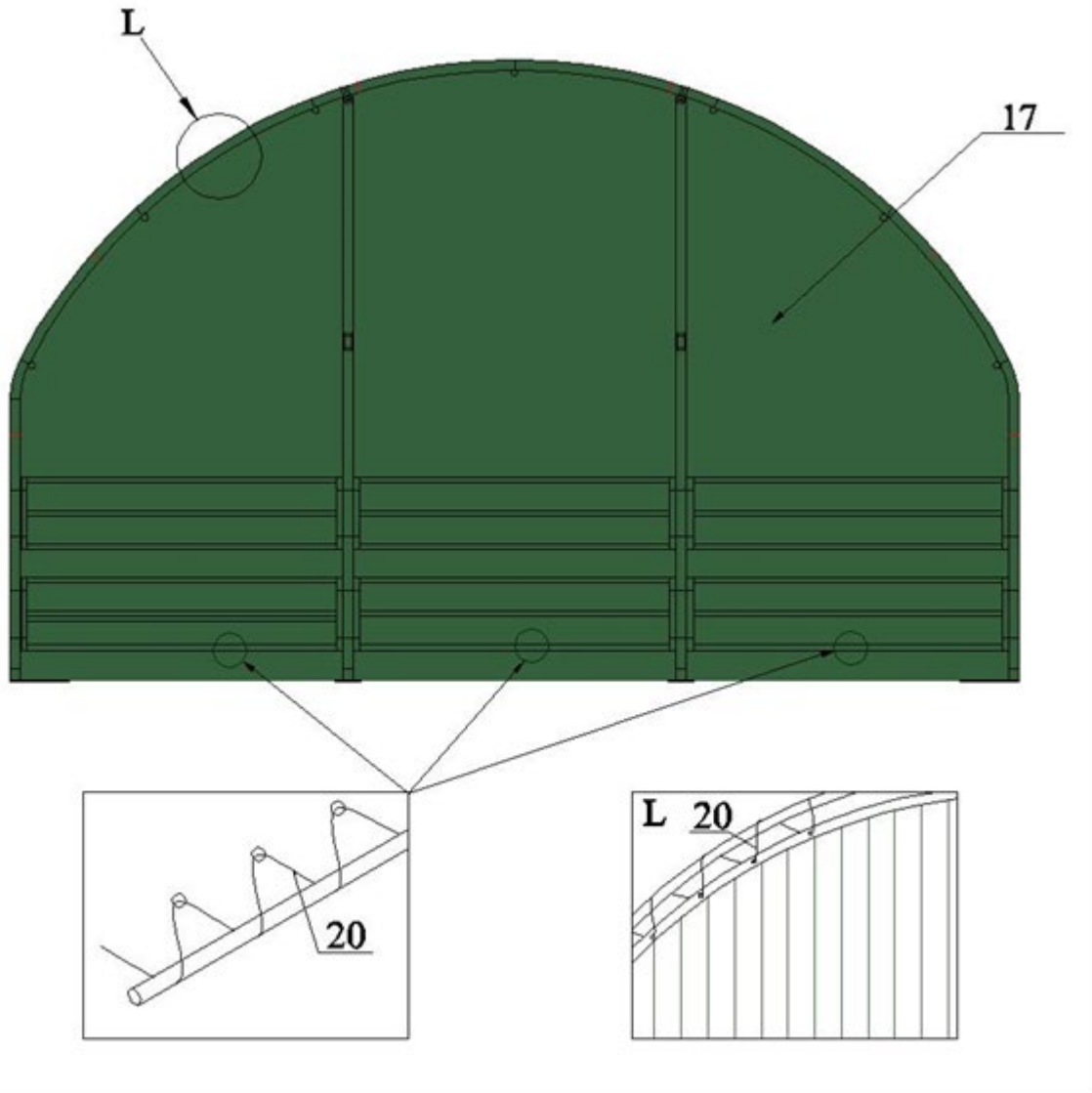

Schritt 2: Dach

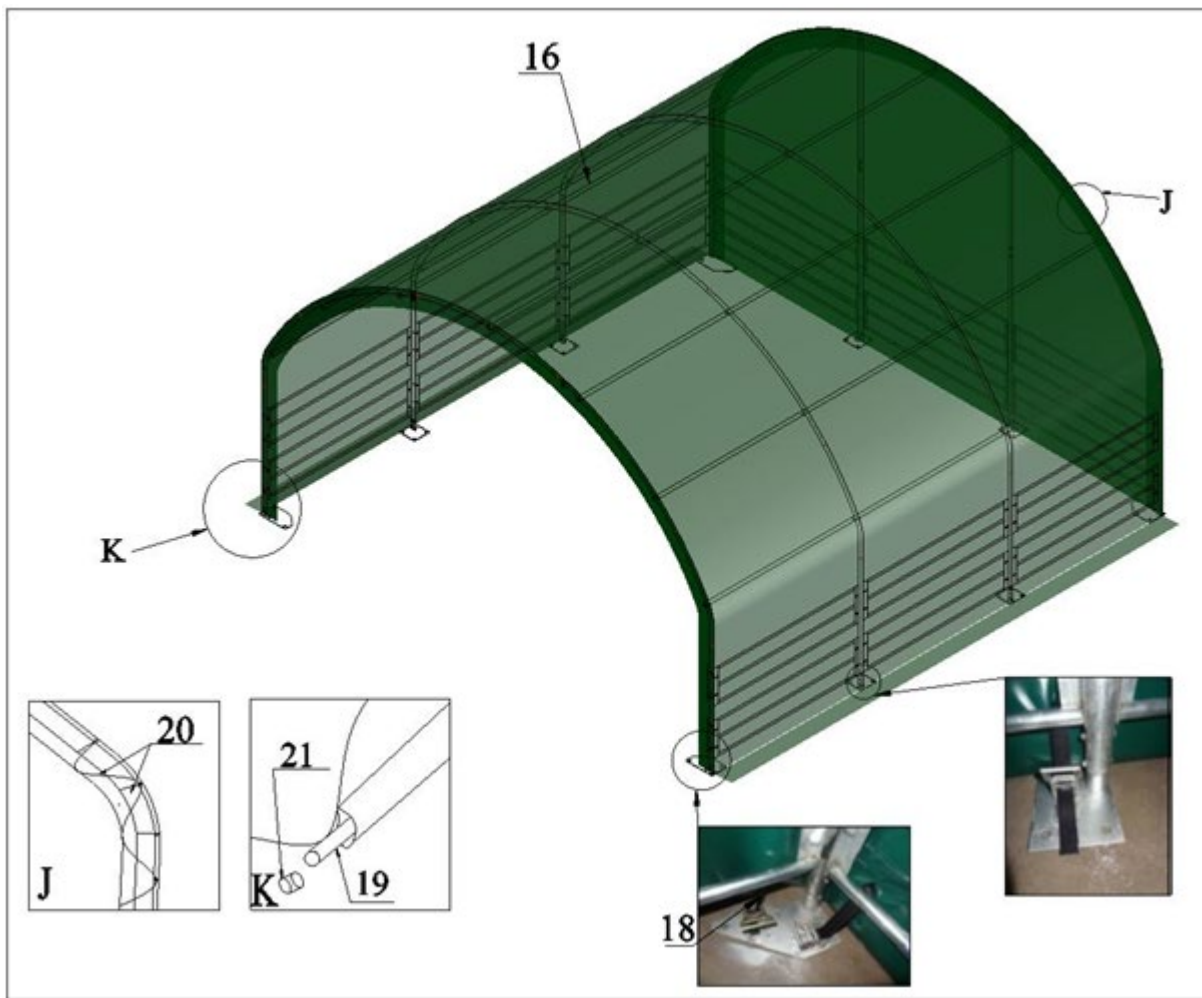

EU-Konformitätserklärung

EU-KONFORMITÄTSERKLÄRUNG		CE
Hersteller:	P. Lindberg A/S Sdr. Ringvej 1 DK-6600 Vejen Tlf.: +45 70212626 E-mail: salg@p-lindberg.dk CVR: 25903110 www.p-lindberg.dk	
Hiermit wird bestätigt dass die folgenden Maschine:	<i>Unterstand für Tiere (offen)</i> <i>PL Artikelnummer 90 55 915</i>	
Typ / Modell:	SS-606	
Entspricht den folgenden Richtlinien:	2011/305/EEC	
Angewandte Standards und Normen:	EN 13782:2005	
Datum und Unterschrift:	Vejen d. 11-01-2022 P. Lindberg A/S  Erik T Lauritsen Direktør	
	CE	

Wir behalten uns das Recht vor, ohne vorherige Information technische Parameter oder Spezifikationen für dieses Produkt zu ändern.

GB

Assembly Instructions

(Translation of original Danish
assembly instructions)



Livestock Tent – Item no. 9055914

Description: Tent with galvanized steel frame and PVC cover. W6 x L6 x H3,7 meter.

Applications: For storage of goods, as well as animal shelter for protection against wind and weather, insects, sun, etc.



IMPORTANT

Be aware that in some countries there may be requirements for approval for the erection of tent halls - therefore always check with local authorities.



IMPORTANT

Snow and ice can cause the tent to collapse. Immediately remove any accumulated snow or ice from the roof structure with a broom, mop or other soft-sided instrument. Use extreme caution when removing snow from cover- always remove from outside the structure - never from the inside. DO NOT use hard-edged tools or instruments like rakes or shovels to remove snow. This could result in punctures to the cover.

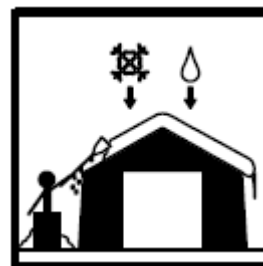

Safety Instructions:

Please read instructions COMPLETELY before assembly. This shelter MUST be securely anchored. THIS IS A TEMPORARY STRUCTURE AND NOT RECOMMENDED AS A PERMANENT STRUCTURE.

Danger:

Prior to installation, choose the location of your shelter carefully.

DANGER: Keep away from electrical wires.

Check for overhead utility lines, tree branches or other structures. Check for underground pipes or wires before you dig. DO NOT install near roof lines or other structures that could shed snow, ice or excessive run off onto your shelter. DO NOT hang objects from the roof or support cables.



WARNING:

Risk of fire. DO NOT smoke or use open flame devices (including grills, fire pits, deep fryers, smokers or lanterns) in or around the shelter. DO NOT store flammable liquids (gasoline, kerosene, propane, etc.) in or around your shelter. Do not expose top or sides of the shelter to open fire or other flame source.



CAUTION:

Use **CAUTION** when erecting the frame. Use safety goggles during installation. Secure and bolt together overhead poles during assembly. Beware of pole ends.

Before you start: 4+ individual recommended for assembly.

PROPER ANCHORING AND INSTALLATION OF FRAME:

PROPER ANCHORING OF THE FRAME IS THE RESPONSIBILITY OF THE CONSUMER.

We are not responsible for damage to the unit or the contents from acts of nature.

Any shelter that is not anchored

securely has the potential to fly away causing damage, and is not covered under the warranty. Periodically check the anchors to ensure stability of shelter. We cannot be responsible for any shelter that blows away.

NOTE: Your shelter's cover can be quickly removed and stored prior to severe weather conditions. If strong winds or severe weather is forecast in your area, we recommend removal of cover.

CARE AND CLEANING:

A tight cover ensures longer life and performance. Always maintain a tight cover.





Loose fabric can accelerate deterioration of cover fabric.





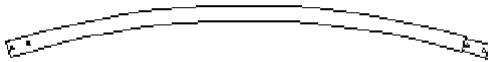
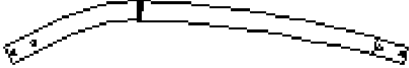
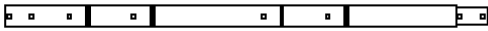
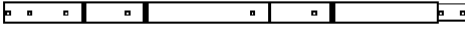
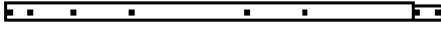
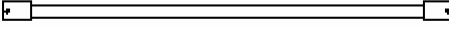
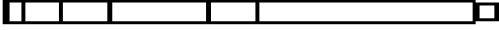

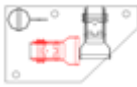
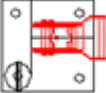

DO NOT use bleach or harsh abrasive products to clean the fabric cover. Cover is easily cleaned with mild soap and water.

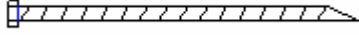
RECOMMENDED TOOLS:

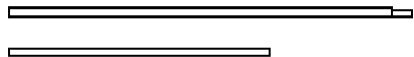

Parts list:

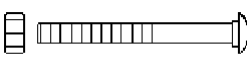
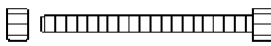
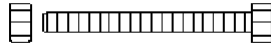
No.	Description	Qty.
1	Top Bent Joist 	4
2	Roof Bent Joist 	8
3	Sidewall Bent Joist 	8
4	Upright for front and back end (left) 	2
5	Upright for front and back end (right) 	2
6	Upright for middle arch 	4
7	Purlin 	21
8	Lower Portal for back end 	2
9	Upper Portal for back end 	2
10	Fence for sidewall 	12
11	Fence for back end 	6
12	Base Plate for corners 	4
13	Base Plate for middle arch 	4

14	Base Plate for back end		2
15	Stake Peg		28
16	Roof Cover		1
17	Back Cover		1
18	Belt for Winch		8
19	Tensioning Tube for roof cover (3pcs/set)		2 sæt
20	Knitting Rope for roof cover		1 bundt
21	Plastic Plug for No.19		4
22	Carriage Bolt M10x80 for purlins		52 + 2
23	Bolt M8x70 for swaged tube		72 + 2
24	Bolt M10x80 for fence		24 + 2
25	Tube Clip		2

Frame Installation

Step 1: base plates and stake pegs

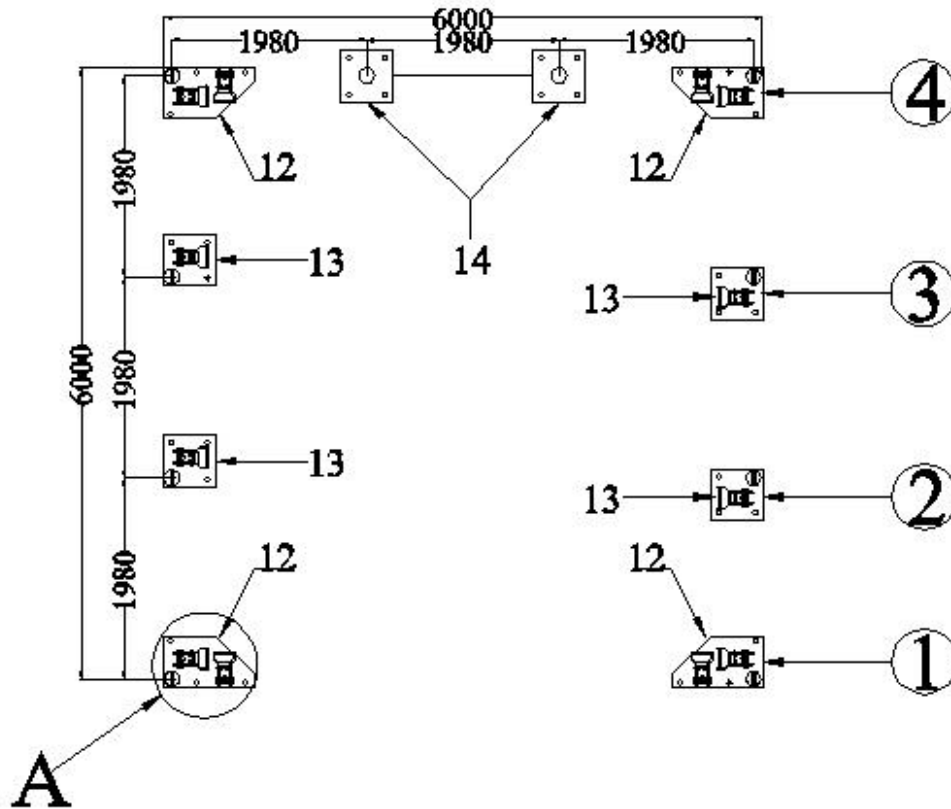

FRONT

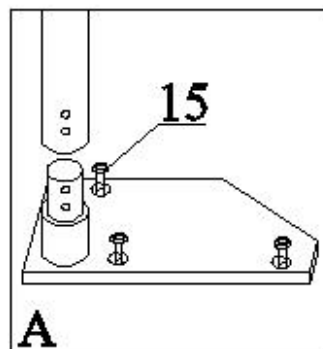
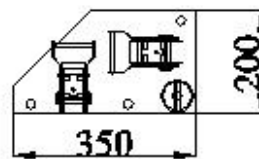
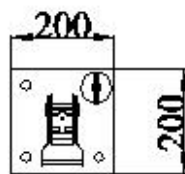

Step 2: arch No.1

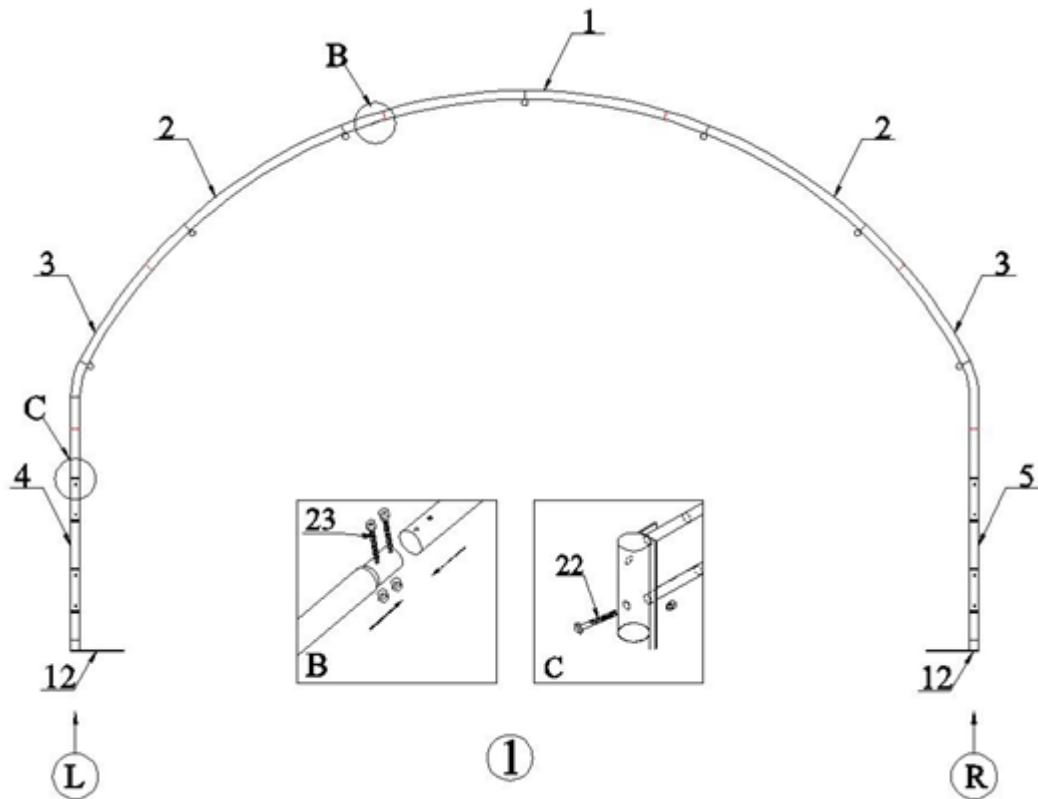

Step 3: middle arches No.2 & 3

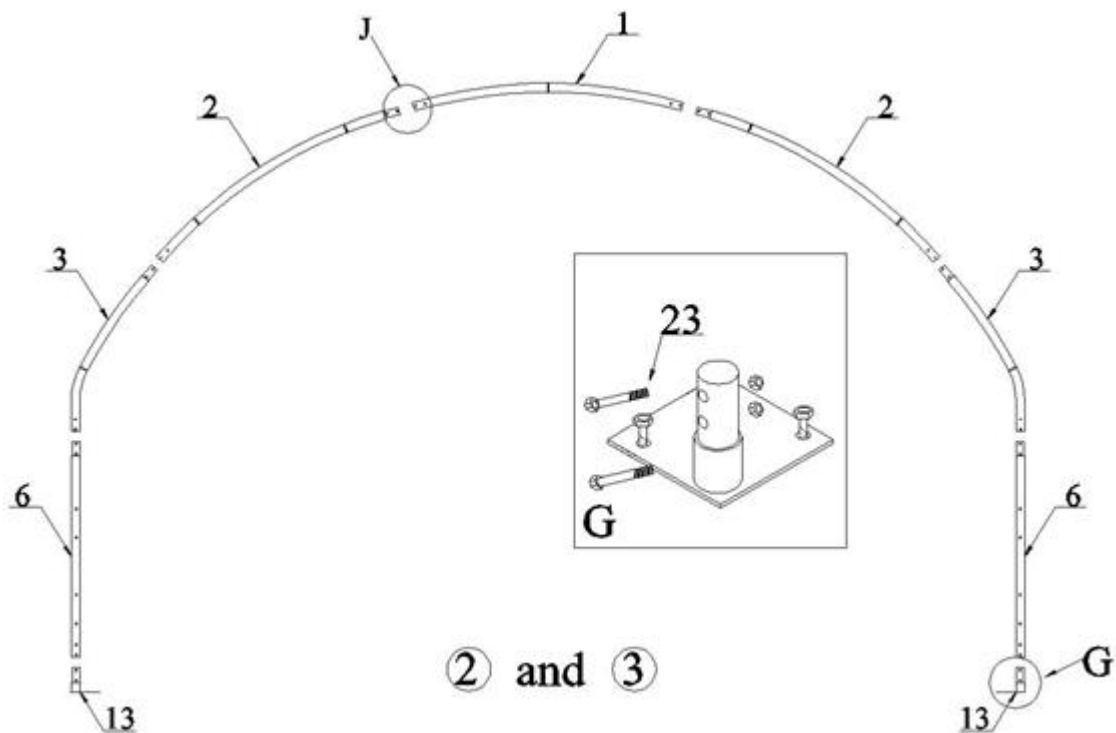

Step 4: arch No.4 and portals and fences

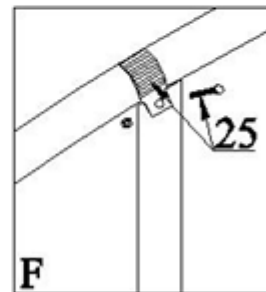
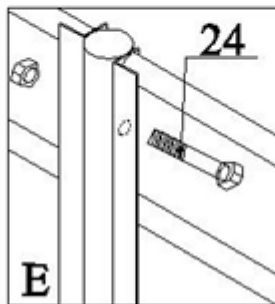
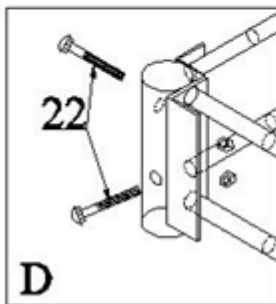
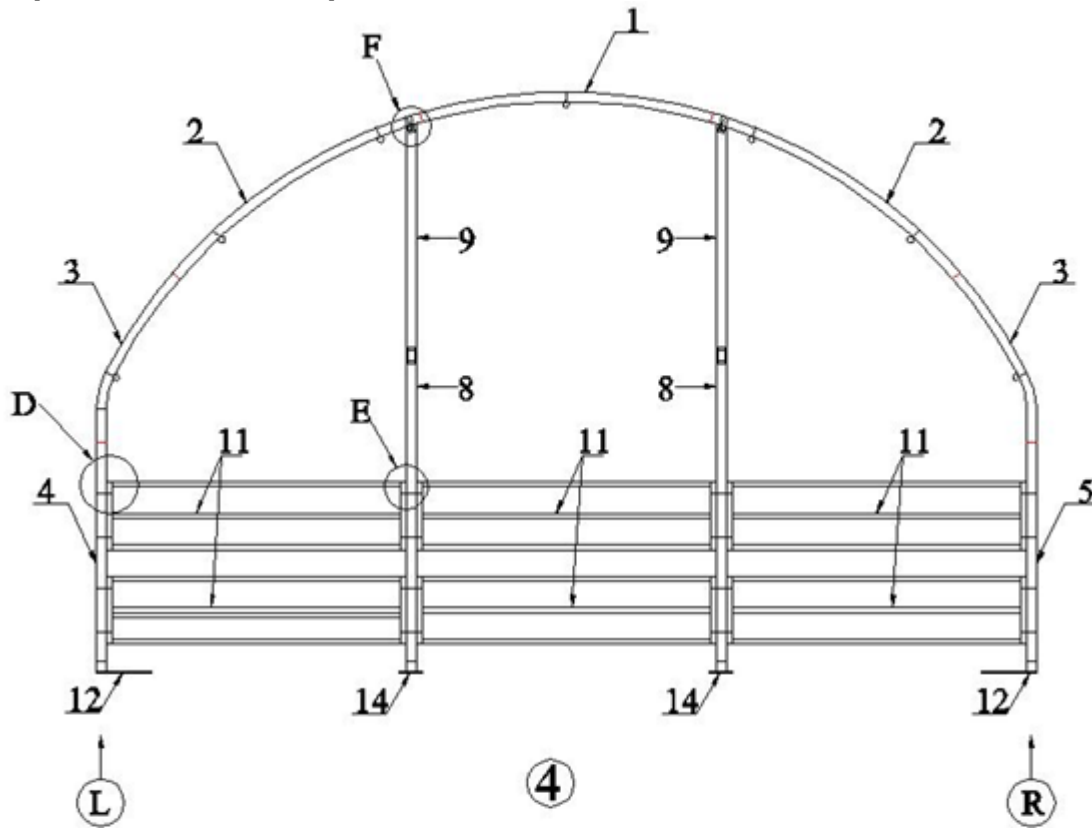

Step 5: purlins and sidewall fences

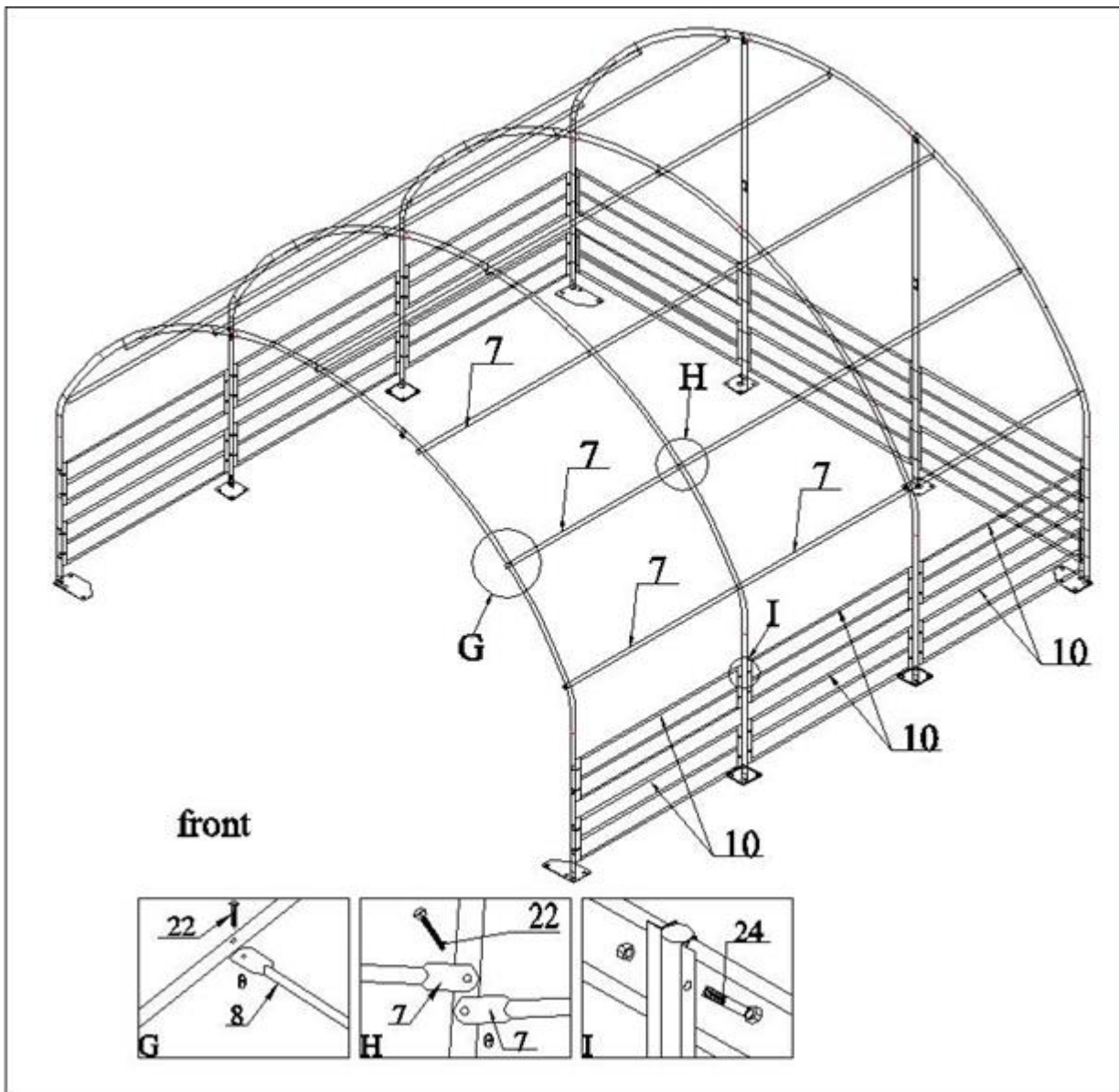

Step 6: squaring up the frame and fix base plates by stake peg

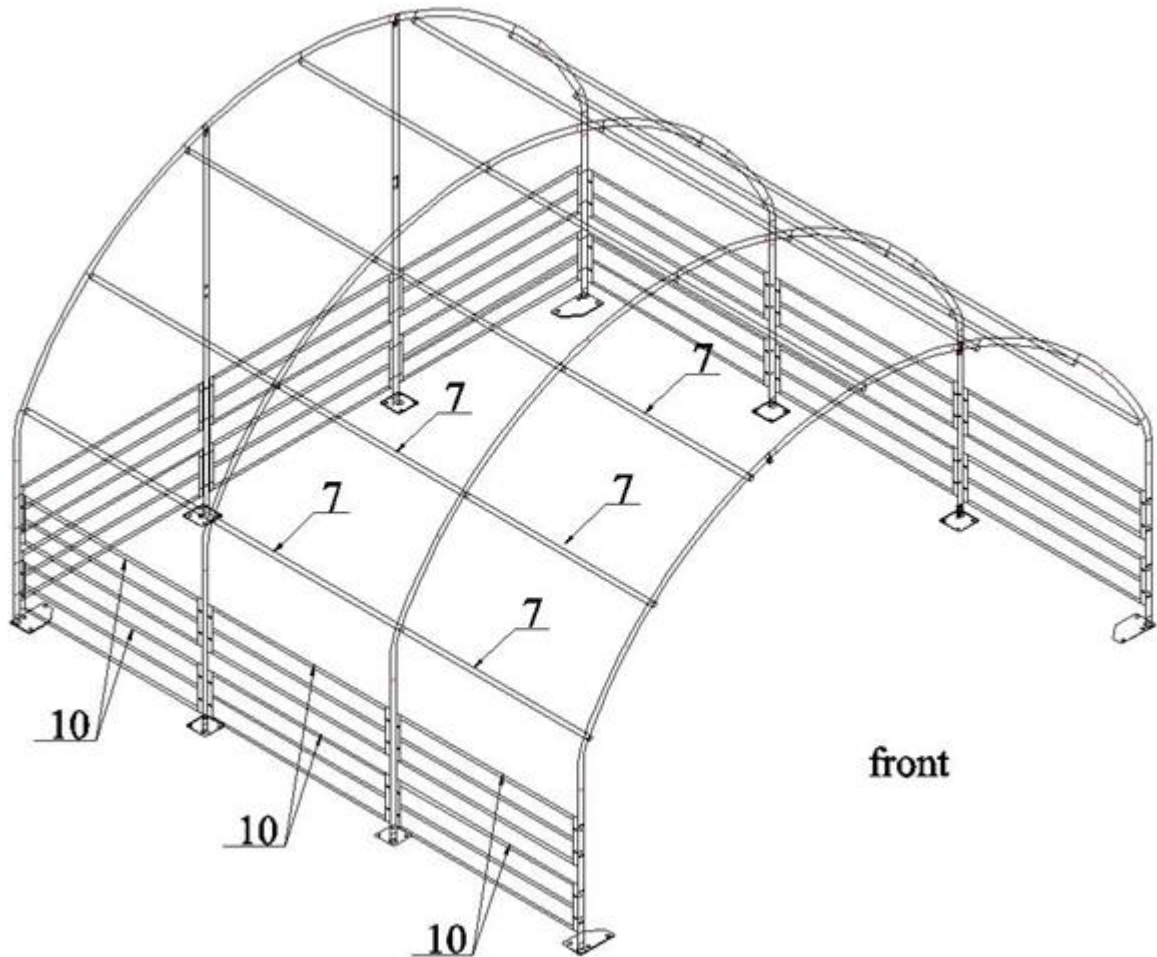

Cover Installation

Step 1: back cover

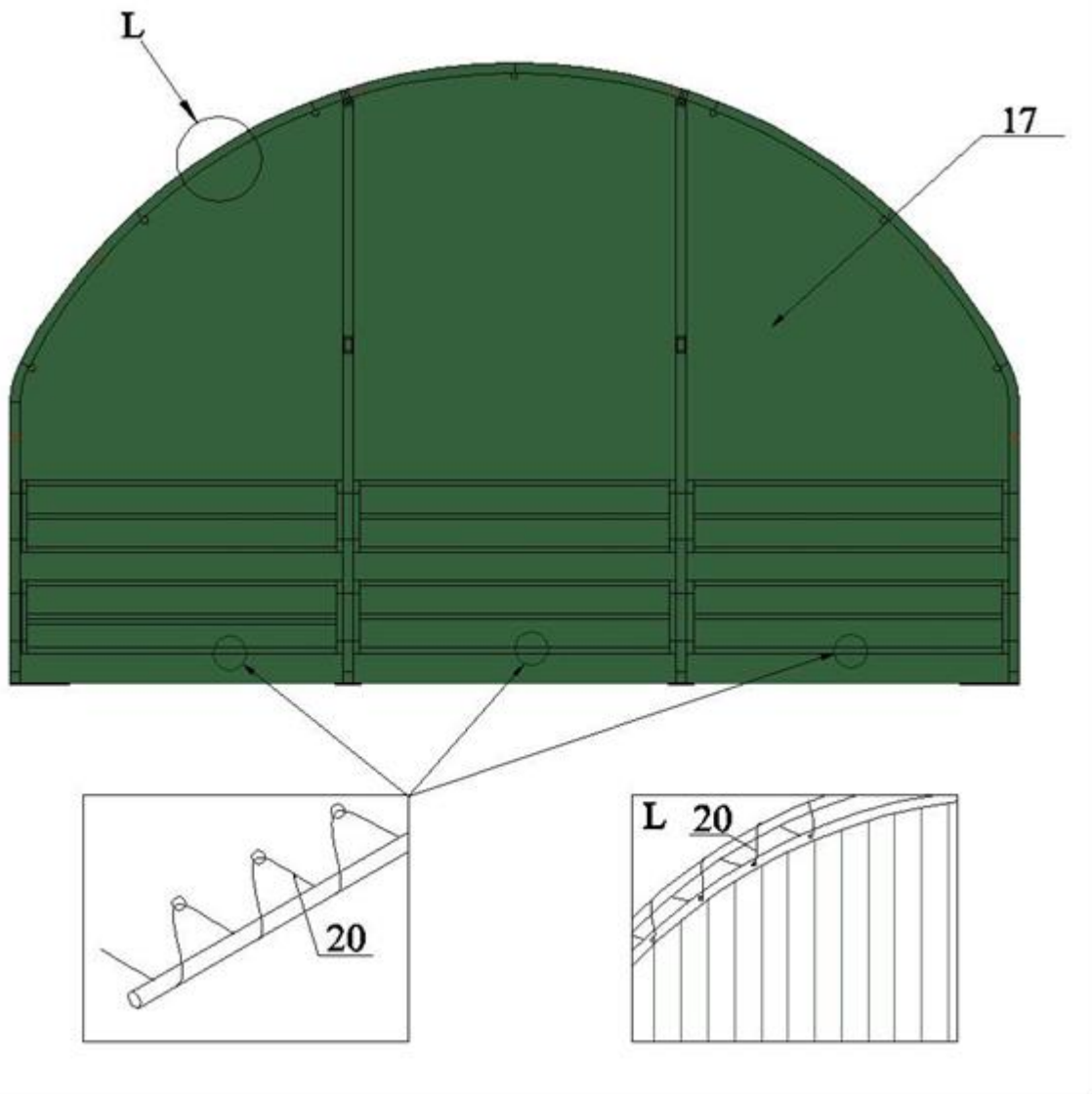

Step 2: roof cover

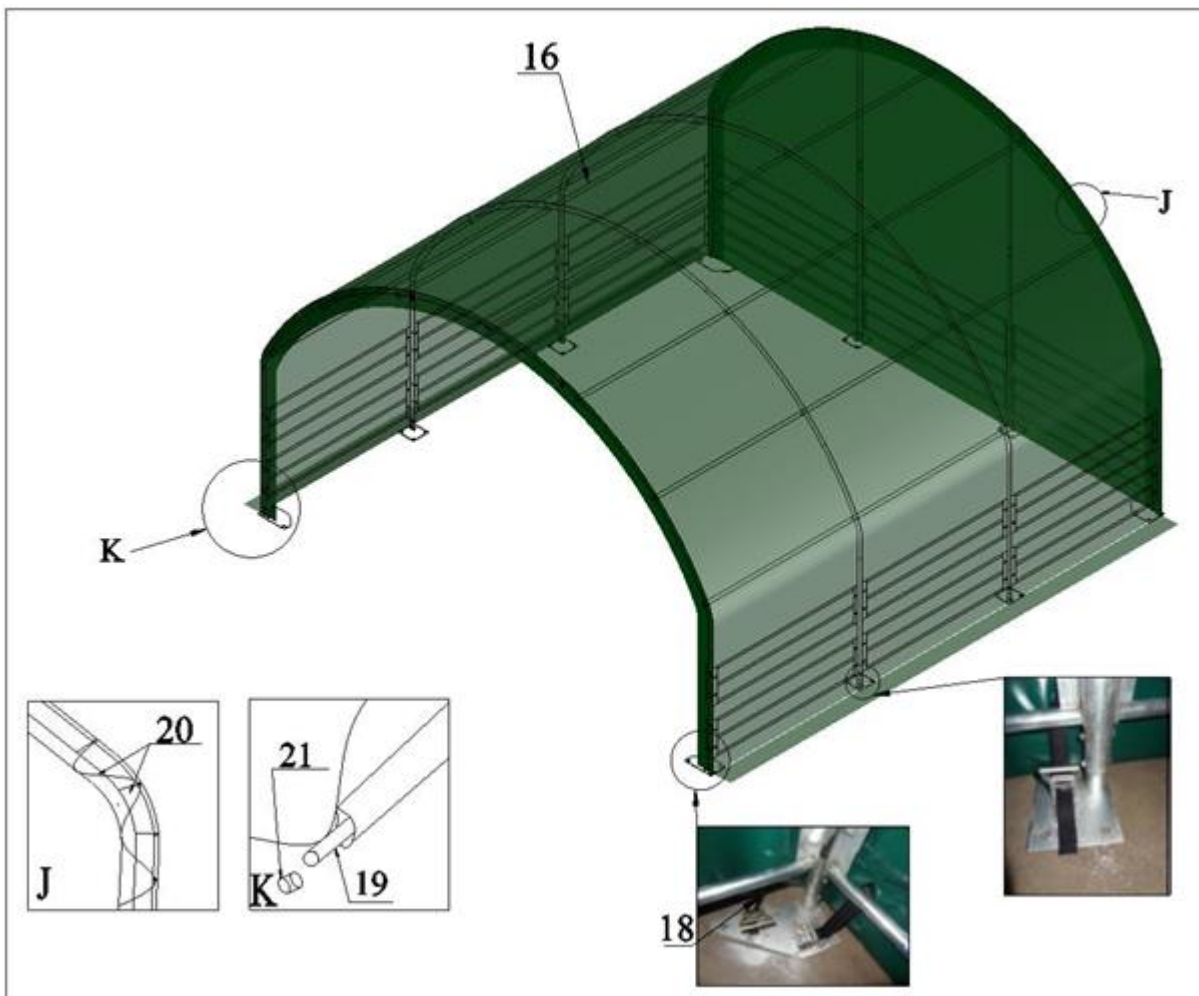

Now your assembly is completed.

EU overensstemmelseserklæring

EU DECLARATION OF CONFORMITY		CE	
Manufacturer:	P. Lindberg A/S Sdr. Ringvej 1 DK-6600 Vejen Phone: +45 70212626 E-mail: salg@p-lindberg.dk CVR: 25903110 www.p-lindberg.dk		
Hereby declare that the following machine:	<i>Livestock Tent (open front)</i> <i>PL item number 90 55 914</i>		
Type / model:	SS-606		
Complies with the following directives:	2011/305/EEC		
Applied standards and norms:	EN 13782:2005		
Date and signature:	Vejen d. 11-01-2022 P. Lindberg A/S  Erik T Lauritsen Direktør		CE

We retain the right to change the technical parameters and specifications of this product without prior notification.