

Installation manual

Montageanleitung • Notice de montage • Istruzioni per il montaggio • Manual de montaje • Monteringsanvisning •
Installatiegids • Montážní návod • Asennusohje • Installationsmanual

Log cabin FR34-4232

Blockhaus • Maisonnette en poutres • Casa di travi • Casa de jardin • Anneks • Tuinhuis • Zahradní domek •
Timmerstuga • Hirsimökki

Width 420 x Depth 320 cm











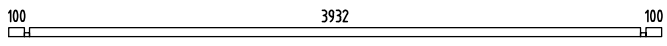
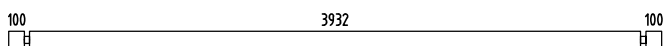
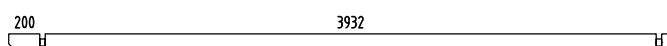
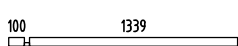
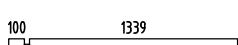

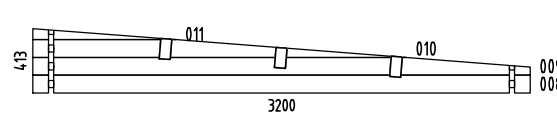
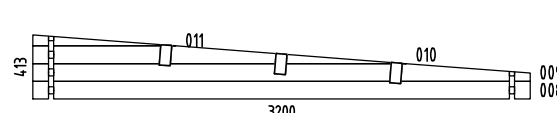
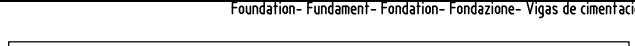
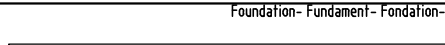
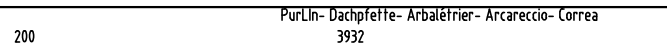

Breite/Tiefe • Largeur/Profondeur • Lunghezza/Profondità • Ancho/Profundidad • Bredde/Dybde • Breedte/Diepte
• Šířka/Hloubka • Leveys/Pituus • Bredd/Längd

Log thickness 34 mm



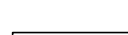





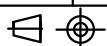



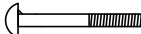
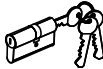





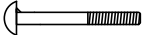

Bohlenstärke • Épaisseur des murs • Spessore delle pareti • Grosor de pared • Tykkelse • Wanddicke • Tloušťka
stěny • Seinän paksuus • Väggtjocklek



The producer shall have the right to make technical changes to the product • Technische Änderungen vorbehalten • Le
producteur réserve le droit d'effectuer des modifications techniques au produit • Il produttore mantiene il diritto di apportare
modifiche tecniche al prodotto • Reservado el derecho a modificaciones técnicas • Produsent forbeholder seg retten til å endre
tekniske egenskaper ved produktet • Alle rechten en technische wijzigingen voorbehouden • Výrobce si vyhrazuje právo na
technické změny výrobku • Valmistaja pidättää oikeuden tehdä tuotteeseen teknisiä muutoksia • Tillverkaren har rätt att utföra
tekniska förändringar för produkten

Pos	SPECIFICATION-STÜCKLISTE-NOMENCLATURE-ELEMENTI-ESPECIFICACIÓN FR34-4232	Pcs	Profile (mm)	Length (mm)
001		1	34x57	4200
002		19	34x114	4200
003		2	34x114	4400
004		2	34x57	1473
005		10	34x114	1473
006		24	34x114	263
007		24	34x114	200
008		34	34x114	3200
WA-1		1		
WB-1		1		
AR2	Foundation- Fundament- Fondation- Fondazione- Vigas de cimentación 	2	60x80	3990
AR1	Foundation- Fundament- Fondation- Fondazione- Vigas de cimentación 	7	60x80	2870
PR1	Purlin- Dachpfette- Arbalétrier- Arcareccio- Correa 	3	70x140	4400
RB2-1	Roof board- Dachbrett- Madrier du toit- Tavola tetto- Tabla de tejado 	50	89x19	3650
FB2-1	Floor board - Fussbodenbrett - Madrier du plancher - Tavola pavimento 	33	89x19	3925
EaE6-1	Eave edging- Dachrandbrett- Madrier en bordure du toit- Tavola bordo tetto- Tabla de valadizo 	2	19x120	4480
FaB7-1	Facia board- Giebelblende- Écran frontal- Schermo frontone- Tabla de facia 	2	19x120	3650
FIB2-1	Floor beading- Fussbodenleiste- Baguette du plancher- Llistello pavimento- Listón de suelo 	9	19x19	1466
RE2-1	Roof edge reinforcement- Dachrandleiste- Baguette en bordure du toit- Rinforzo bordo tetto- Refuerzo borde tejado 	4	32x40	2200
SlA8-1	Slat- Leiste- Baguette- Llistello- Listón 	1	19x35	1250
StB1-1	Storm brace- Sturmleiste- Protection contre le vent- Antivento- Protector contra tormentas 	2	25x45	2050
StB1-2	Storm brace- Sturmleiste- Protection contre le vent- Antivento- Protector contra tormentas 	2	25x45	2250
WG1-1	Water gutter- Wasserleiste- Rejet d'eau- Protección de lluvia- Protezione dalla pioggia 	2	19x33	1130

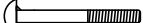
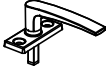
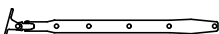
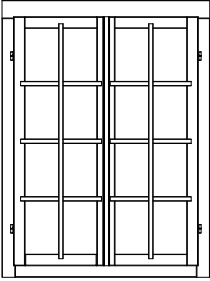

Pos	SPECIFICATION-STÜCKLISTE-NOMENCLATURE-ELEMENTI-ESPECIFICACIÓN FR34-4232	Pcs	Profile (mm)	Length (mm)	
WG1-2	Water gutter- Wasserleiste- Rejet d'eau- Protección de lluvia- Protezione dalla pioggia		1	19x33	1370
Fim	-Fixing kit- Befestigungsset- Moyens de fixation- Materiale di fissaggio- Kit de fijación		1	USE	
QPOYP8x 80Zn	Bolt -Schloss-schraube -Boulon- Bullone- Perno- M8x80mm PUP0		8	StB1-1	
QULSI30x 35	Cylinder- Zylinderschloss- Serrure a mortaiser- Serratura a cilindro- Bombin- 30.35		1	TU34-22P	
QLIU KAPal	Door fittings- Türbeschlag- Ferrure- Ferramenta porta- Manilla puerta- QLIUKAPal		1	TU34-22P	
QRV120Zn	Keeper- Schliessblech- Tole- Lamiera- Aldaba de candado		1	TU34-22P	
QNA1 4x 40Me	Nail- Nagel- Clou- Chiodo- Clavo- 1.4x40mm		32	FIB2-1	
QNA2 2 x50Zn	Nail- Nagel- Clou- Chiodo- Clavo- 2.5x50mm		600	RB2-1 FB2-1	
QMUkk8 Zn	Nut- Schraubenmutter- Écrou- Dado- Tuerca- M8mm		8		
QKRPP2 5x16Z n	Screw- Schraube- Vis- Vite- Tornillo- 2.5x16mm		2		
QKRPP3 5x40Zn	Screw- Schraube- Vis- Vite- Tornillo- 3.5x40mm		110	EaE6-1;FaB7-1 FIB2-1...	
QKRPP3x 20Zn	Screw- Schraube- Vis- Vite- Tornillo- 3x20mm		128	TA34-15P TU34-22P	
QKRPP4 5x60Zn	Screw- Schraube- Vis- Vite- Tornillo- 4.5x60mm		20	WG1-1	
QKRPP4 5x70Zn	Screw- Schraube- Vis- Vite- Tornillo- 4.5x70mm		16	003;004;001...	
QKRPP5x 90Zn	Screw- Schraube- Vis- Vite- Tornillo- 5x90mm		12	TU34-22R TA34-15R	
QKRPP6x 120Zn	Screw- Schraube- Vis- Vite- Tornillo- 6x120mm		26	ARx;PRx	
QSE8x22 Zn	Washer- Dichtscheibe- Joint- Rondella- Arandela- 8x22mm		8		
QLIA	Window fittings- Fenstergriff- Poigne de la fenêtre- Maniglia finestra- Manilla (ventana)		4	TA34-15R	
QFK240Z n	Window stop- Fensterfeststelle- Crémaillère- Fissativo finestra- Fijador de ventana- QFK240Zn		4	TA34-15R	
TA34-15 P	Window - Fenster - Fenetre - Finestra-Ventana 1003x1336	  903x1236mm	2		

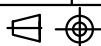

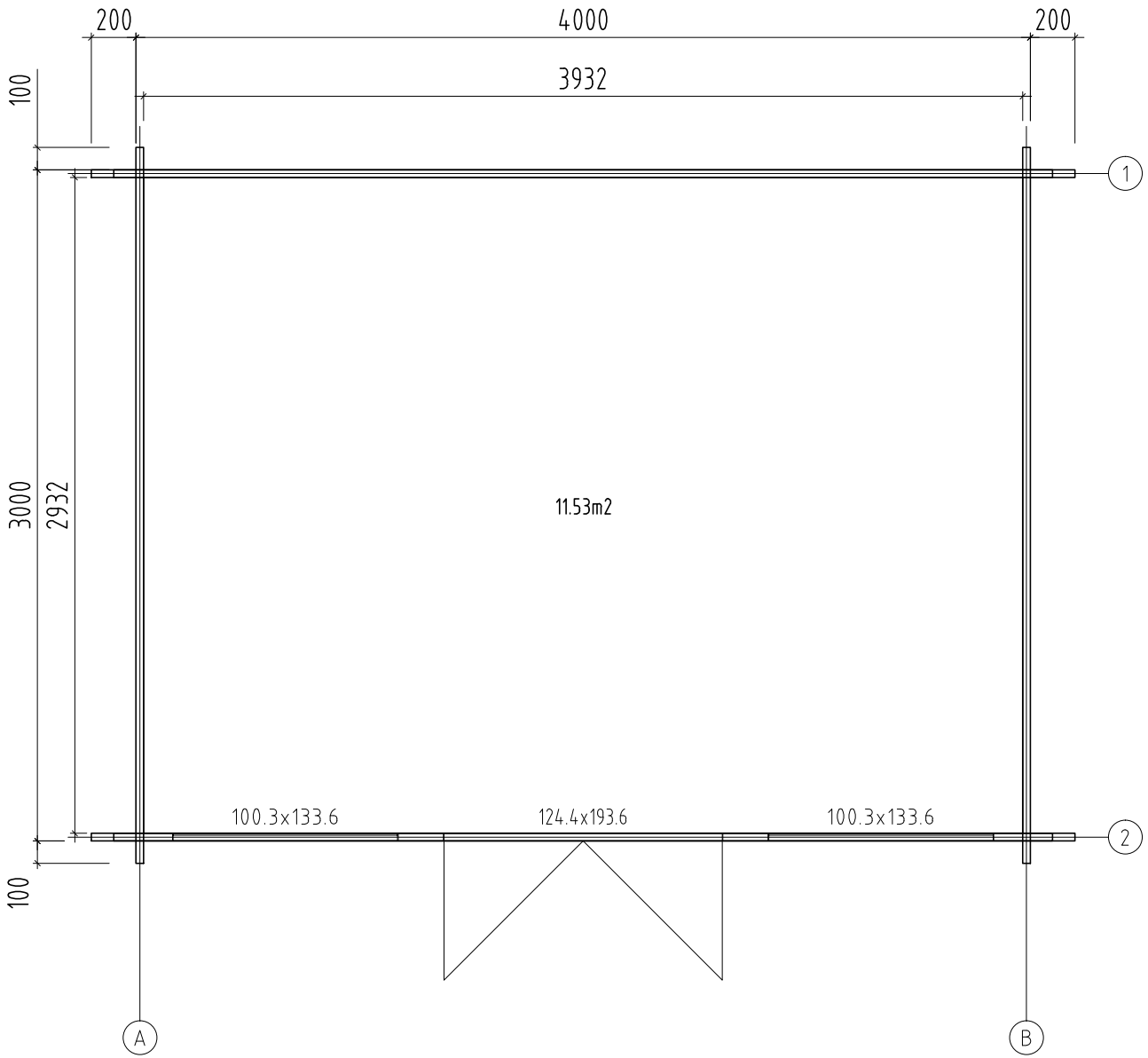

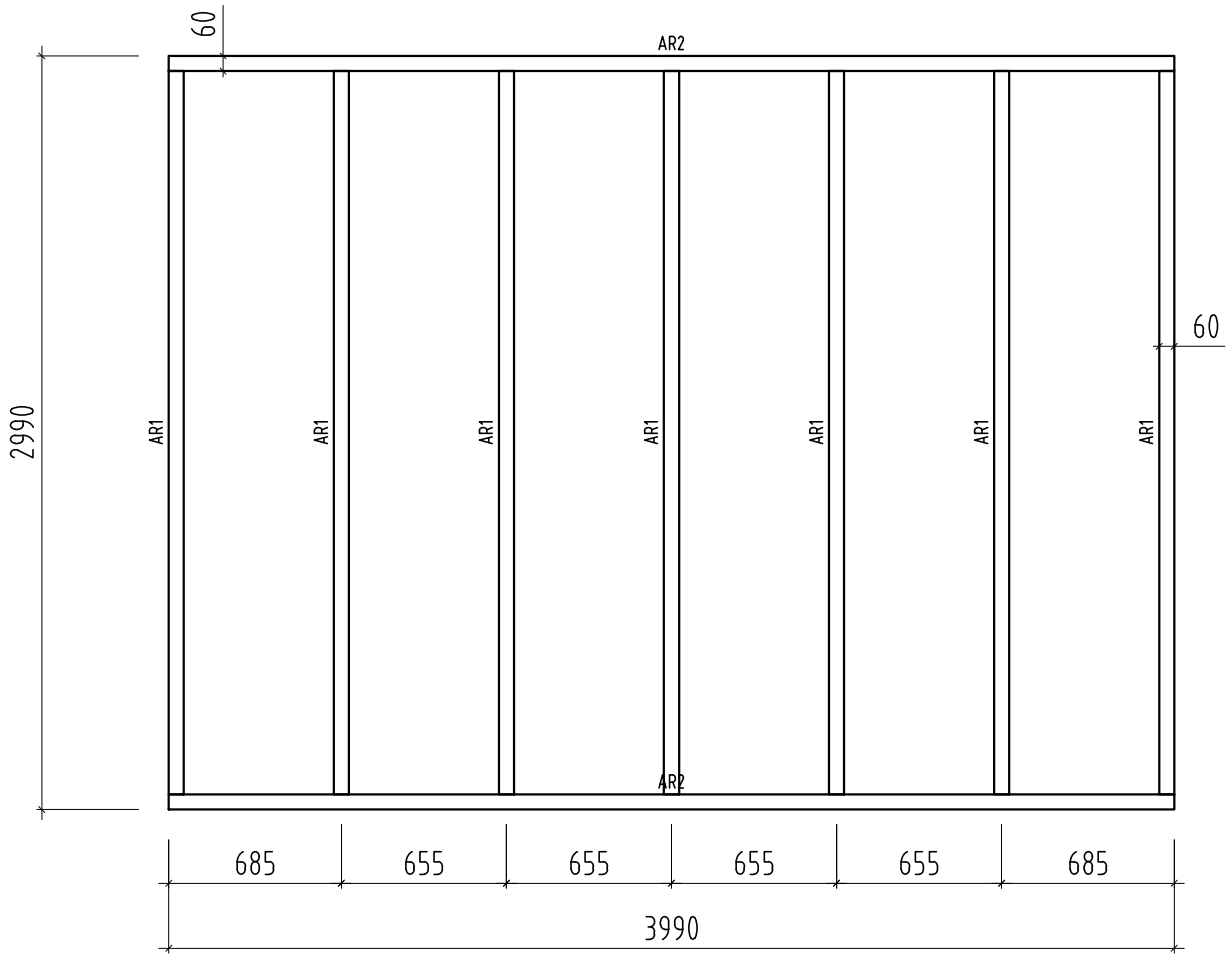

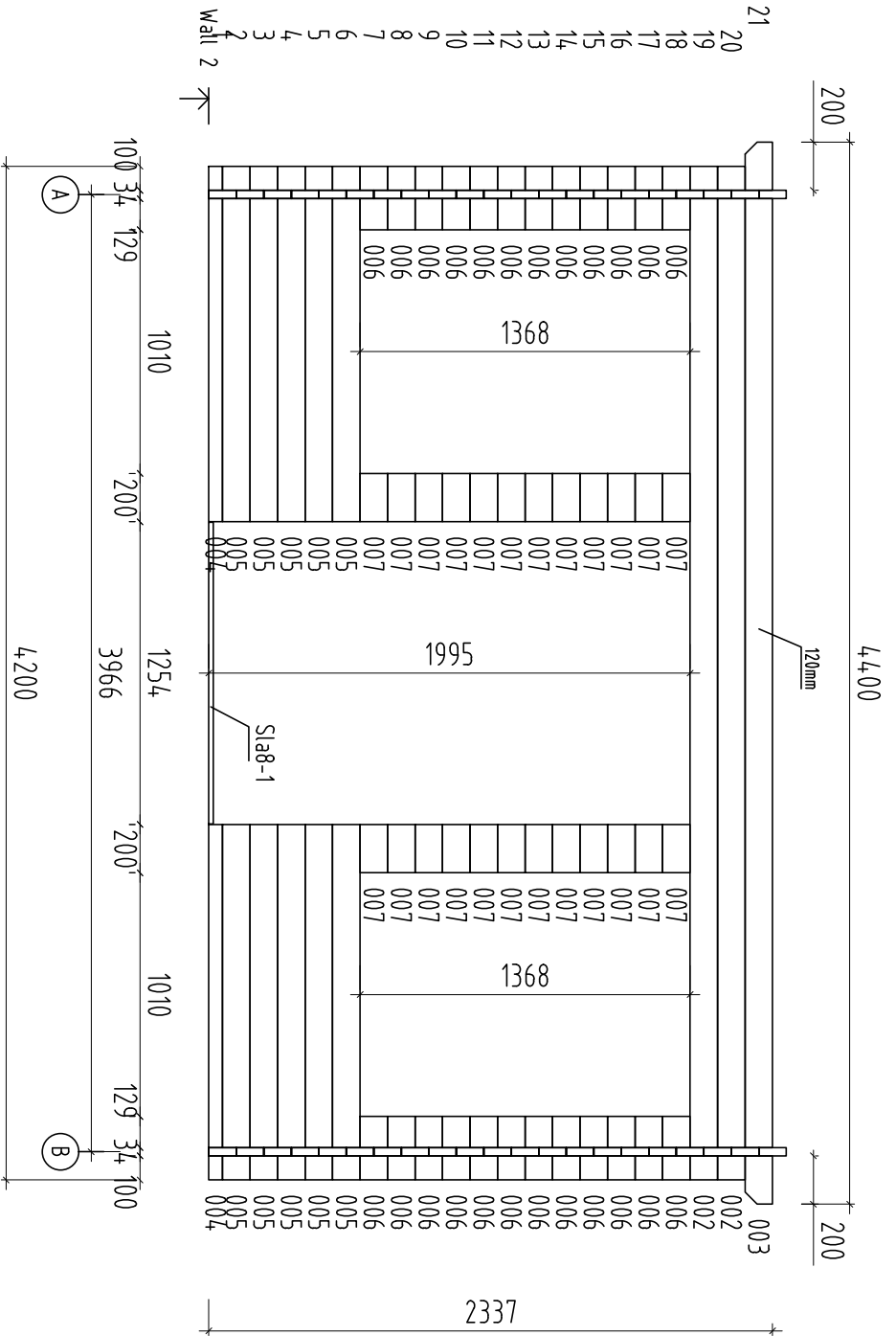

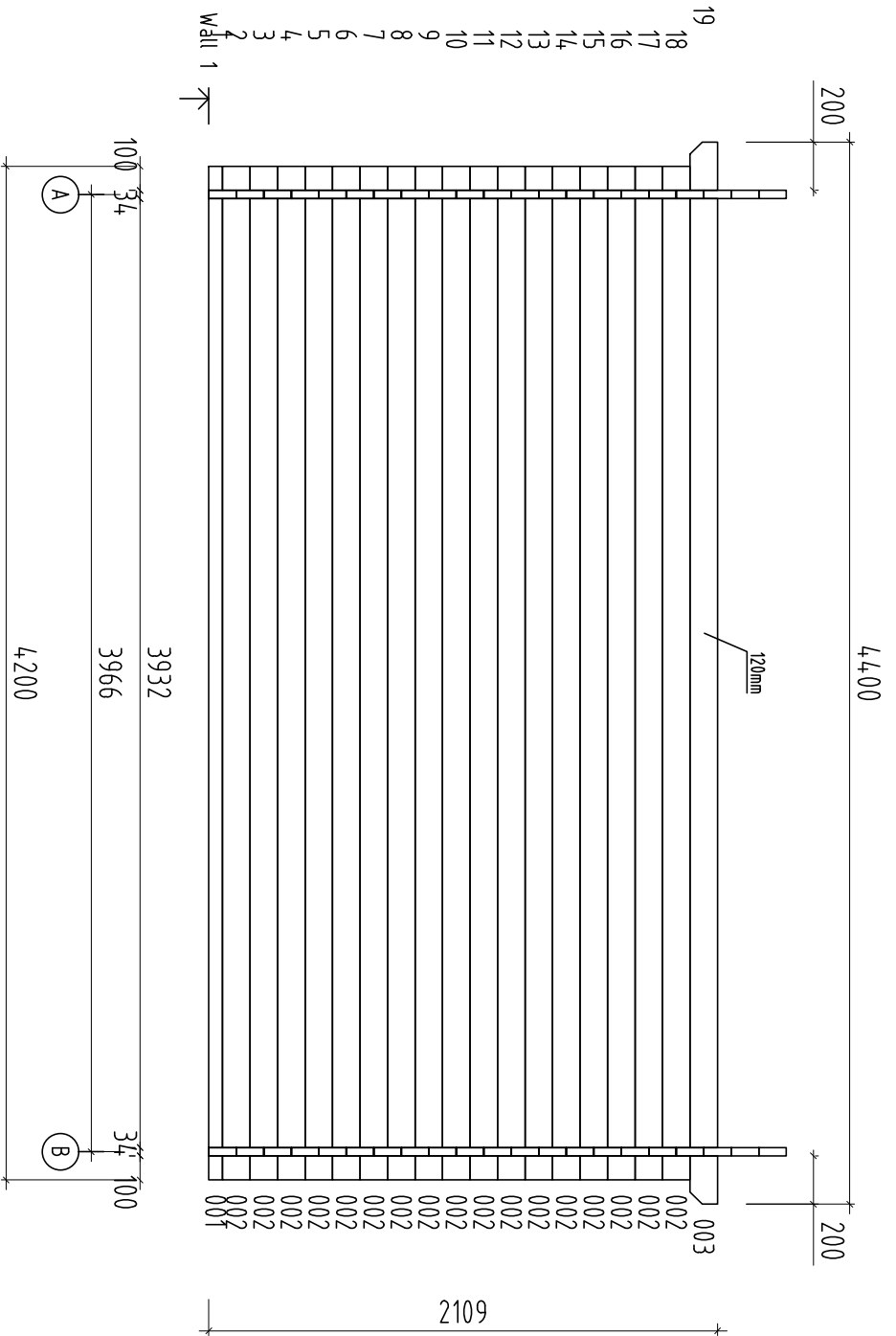

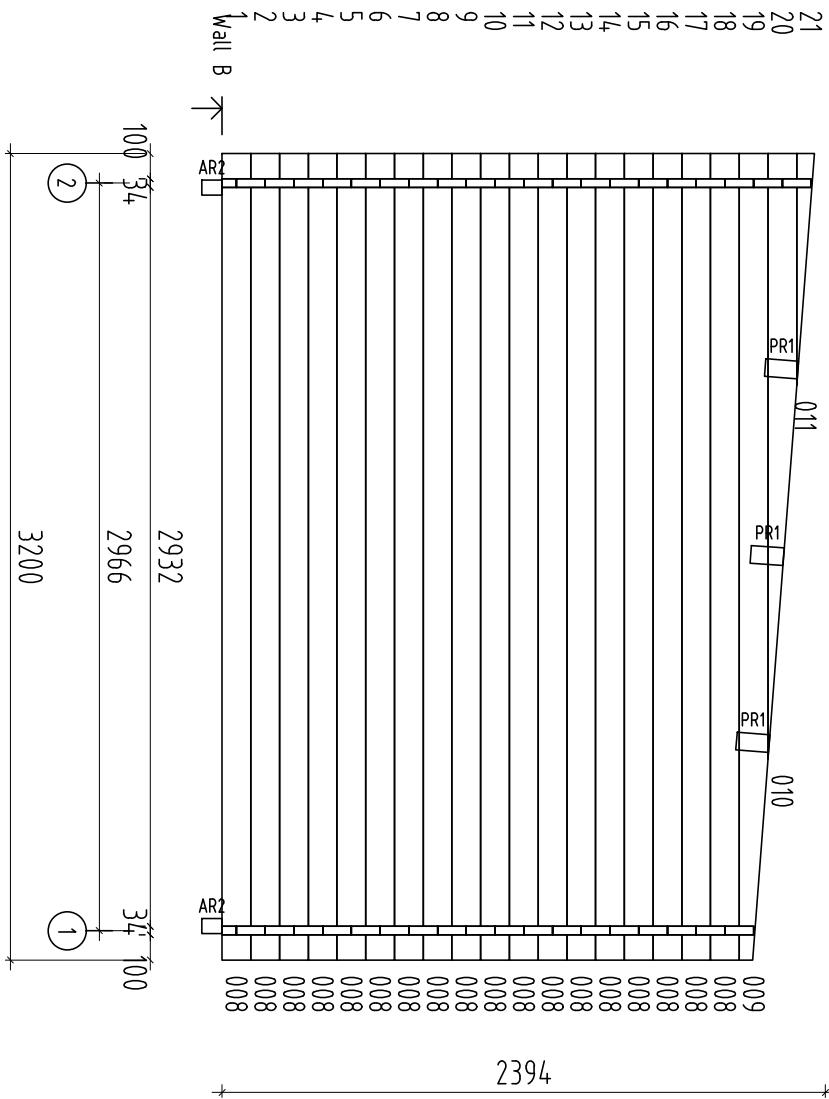

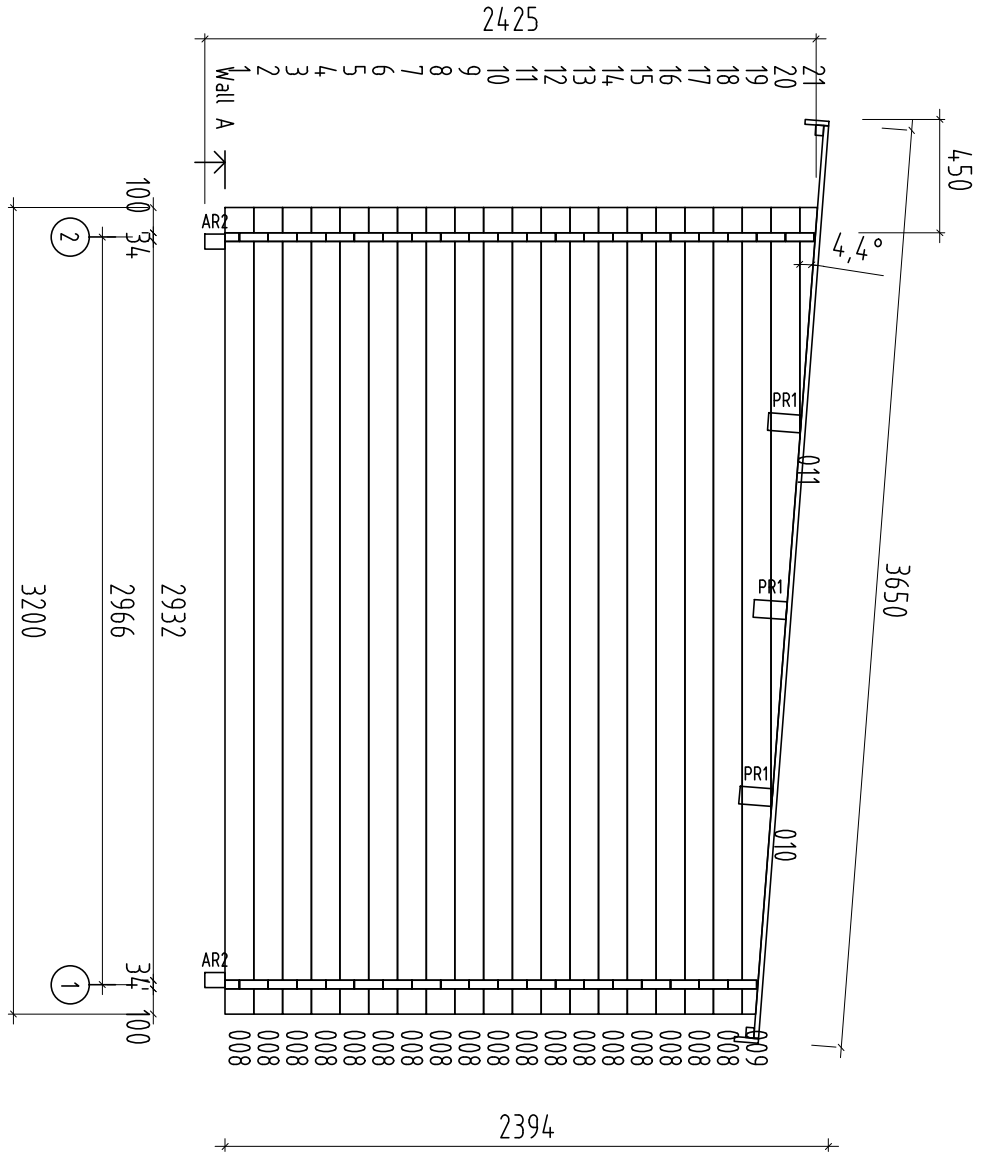

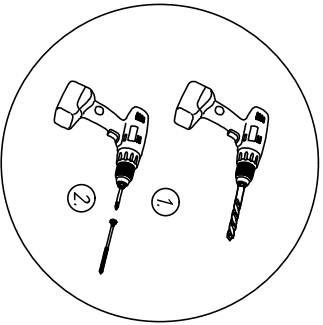
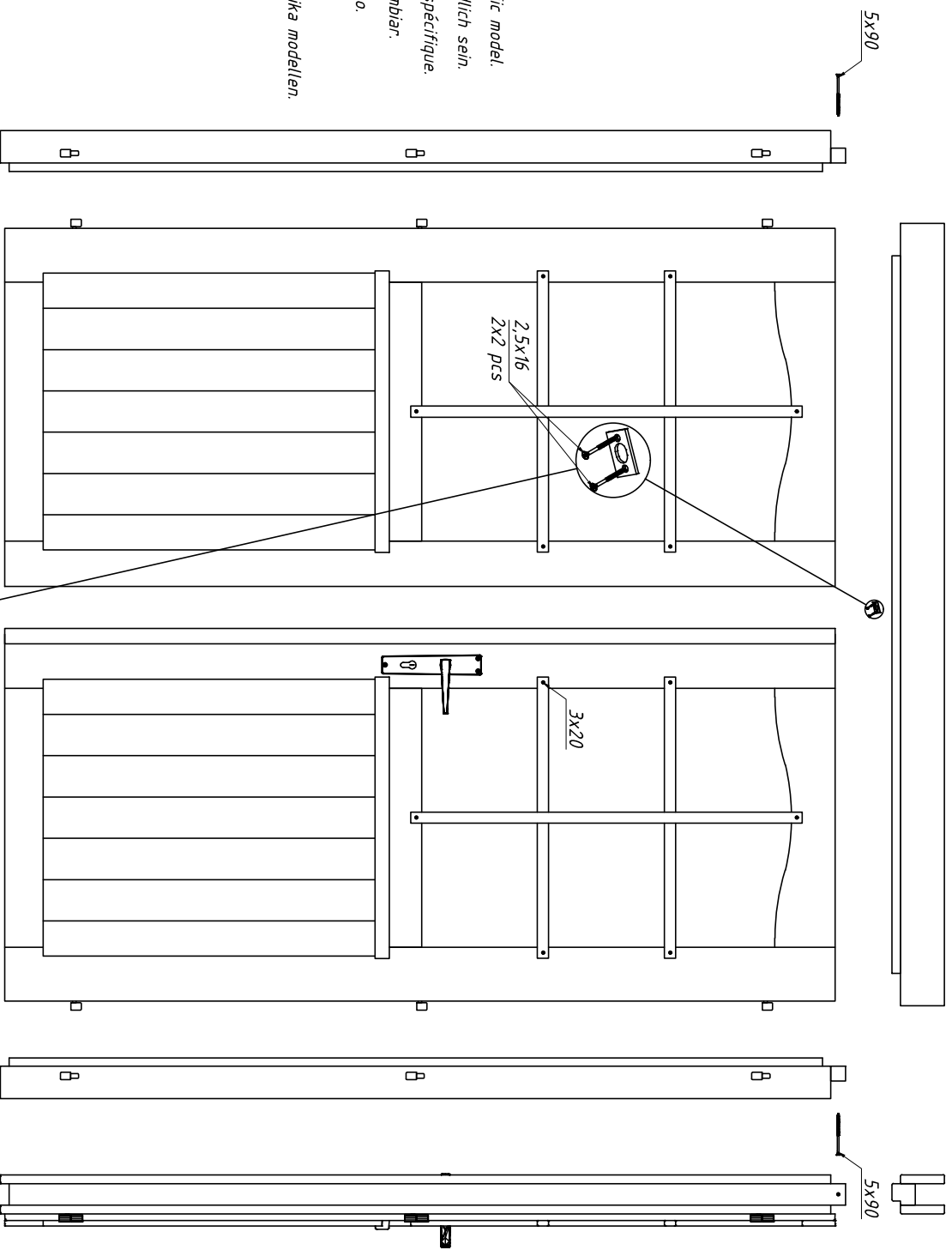
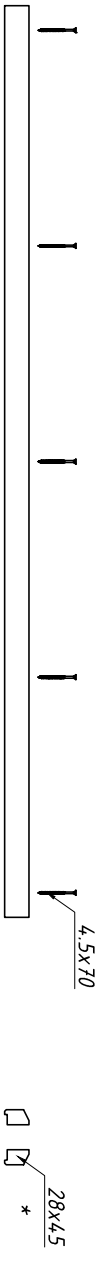

- * The specification may vary depending on the specific model.
- * Die Spezifikation können je nach Modell unterschiedlich sein.
- * Les spécifications peuvent varier selon le modèle spécifique.
- * Dependiendo del modelo, la especificación puede cambiar.
- * Le specifiche possono variare a seconda del modello.
- * Tekniset tiedot voivat vaihdella mallista riippuen.
- * Spezifikationen kan variera beroende på den specifika modellen.

